

OPERATION & MAINTENANCE MANUAL

Molded Case Automatic Transfer Switch

(Single or Dual Motor Operated)

(System Types: 3 ϕ Wye, 3 ϕ Delta, 1 ϕ Polyphase, 1 ϕ Single)

With LSE8600 Controller

Lake Shore Electric LLC.

205 Willis Street
Bedford, OH 44146

Website: www.lake-shore-electric.com
Email: sales@lake-shore-electric.com

Phone: 440.232.0200
Toll Free: 800.225.0141

WARNING!

WHEN WORKING ON EQUIPMENT OF THIS TYPE, EXTREME DANGER OF ELECTROCUTION EXISTS THAT MAY RESULT IN INJURY OR DEATH. DO NOT ATTEMPT ANY REPAIRS OR ADJUSTMENTS TO THIS EQUIPMENT WITHOUT FIRST TAKING THE APPROPRIATE PRECAUTIONS TO PREVENT PERSONAL INJURY AND EQUIPMENT DAMAGE.

DURING INSTALLATION AND USE OF THIS PRODUCT, COMPLY WITH THE NATIONAL ELECTRICAL CODE (NEC), FEDERAL, STATE AND LOCAL CODES, AND ALL OTHER APPLICABLE SAFETY CODES.

MAIN UTILITY POWER MUST BE OFF DURING INSTALLATION, WHEN PERFORMING EQUIPMENT MAINTENANCE OUTSIDE THE EQUIPMENTS NORMAL MAINTENANCE SCOPE AND WHEN PERFORMING REQUIRED MAINTENANCE ON ANY POWER CABLE(S) CONNECTED TO THE EQUIPMENT.

! IT IS IMPORTANT TO REVIEW ADDITIONAL INFORMATION AT WWW.LAKE-SHORE-ELECTRIC.COM !

WARRANTY

Lake Shore Electric Automatic Transfer Switches are guaranteed against defective materials and workmanship for a period of one year from date of shipment. If, within one year after shipment, it is proved to Lake Shore's satisfaction that the equipment requires valid warranty work and Lake Shore is promptly notified of same, Lake Shore will make necessary corrections, free of charge. F.O.B. works where manufactured.

Such necessary corrections constitute the full extent of Lake Shore's warranty. There are no warranties, which extend beyond those described herein. This warranty is exclusive and is in lieu of all other warranties, whether written, oral, implied or statutory. No warranty of merchantability or of fitness for purpose shall apply.

Lake Shore is not responsible for damage to its equipment through improper installation or use, unauthorized repair or modifications, or attempts to operate it above its rated capacities or in abnormal environments. In no event, whether as a failure to meet conditions of the warranty or otherwise, shall Lake Shore be liable for any special, incidental, or consequential damages, including, but not limited to, loss of profit or revenues, loss of good will, damages to associated equipment, cost of capital, cost of substitute products, facilities, service or replacement power, costs of downtime or claims of third parties for such damages.

Notice: The owner of this automatic transfer switch must perform certain required maintenance functions as described in **Appendix A, Appendix B, and Appendix C** of this manual in order to maintain Lake Shore's one year exclusive warranty. Failure to perform this maintenance shall void the warranty.

NOTE

Engineering changes may have been made after publication date. Any departure from this manual should be checked with Lake Shore Electric.

Lake Shore Electric Corporation reserves the right to change specifications without prior notice.

Table of Contents

Table of Figures	6
Table of Tables	7
1. Construction.....	8
2. Description of Operation	9
2.1. Single Motor Operator.....	9
2.2. Dual Motor Operator	10
3. Installation	11
3.1. Mounting and Connecting	11
3.2. Placing the Transfer Switch in Operation	15
3.2.1. ATS Control Start-Up	15
4. Controller LSE8600.....	17
4.1. Introduction.....	17
4.1.1. Self-Seeking Power Supply.....	18
4.1.2. Expansion Modules.....	19
4.1.2.1. Relay (8) Output Expansion Module - DSE2157	19
4.1.2.2. Relay (8) Input Expansion Module - DSE2130.....	20
4.1.2.3. LED (8) Annunciator Expansion Module-DSE2548.....	22
4.1.2.4. Ethernet Communication Module - DSE89x.....	24
4.1.3. LSE8600 Controller - Rear Controls (HMI)	27
4.1.4. LSE8600 Controller - Front Controls (HMI).....	31
4.2. Operational Configuration	35
4.2.1. Modes of Operation (Utility to Generator).....	35
4.2.2. Electrical Trips	35
4.2.3. Warnings	36
4.2.4. LED Indicators on HMI Screen.....	37
4.2.5. Accessing Editor With a Pin	38
4.2.6. ATS Time & Date Change.....	39
4.2.7. ATS Timer Settings & Adjustments from LSE8600 Display	40
4.2.8. Timer Factory Default Settings.....	41
4.2.9. ATS Exerciser Settings & Adjustments	42
4.2.10. Undervoltage Trip Settings for S1 and S2 Sources.....	45

4.2.11.	Overvoltage Trip Settings for S1 and S2 Sources.....	45
4.2.12.	Under-Frequency Trip Settings for S1 and S2 Sources	45
4.2.13.	Over-Frequency Trip Settings for S1 and S2 Sources	45
4.3.	Installation	46
4.3.1.	Generic Control Wiring Diagram	46
4.3.2.	Typical Wiring Diagrams - 3 ϕ 4W	47
4.3.3.	Typical Wiring Diagrams - 3 ϕ 3W	47
4.3.4.	Typical Wiring Diagrams - 1 ϕ 2W	48
4.3.5.	Typical Wiring Diagrams - 2 ϕ 3W (L1-L2).....	48
4.3.6.	Typical Wiring Diagrams - 2 ϕ 3W (L1-L3).....	49
5.	Operating Mechanism	50
5.1.	General Information	50
5.2.	Operation.....	50
5.3.	Required Maintenance.....	50
5.4.	Motor Assembly	50
6.	Molded Case Switches.....	52
6.1.	General Information	52
6.2.	Inspection and Maintenance	52
7.	Troubleshooting Guide.....	53
7.1.	LSE8600 Configuration Suite Software Installation Instructions	55
7.2.	LSE8600 Controller Issues	63
7.3.	Relay Expansion Board(s) (If Applicable).....	64
7.3.1.	DSE2130 - Input Expansion Board	64
7.3.2.	DSE2157 - Output Expansion Board	66
7.3.3.	DSE2548 - LED Annunciator Expansion Board	67
7.4.	Other Issues	69
8.	Standard and Optional Accessories	70
8.1.	Service Entrance (Optional).....	70
8.2.	Ground Fault Protection or Indication - GFP / GFPE / GFPL / GFI (Optional).....	71
8.3.	Auxiliary Contacts Before Transfer - ACBT (Standard).....	72
8.4.	Surge Suppression TVSS - SPD (Optional).....	73
8.5.	Remote Disconnect - RD (Optional)	73
8.6.	Circuit Breaker Trips - CBTN / CBTE (Optional).....	73
8.7.	Source Available Auxiliary Contacts - ACSA (Standard).....	73

8.8.	Mode - Test On Load (Standard).....	74
8.9.	Mode - Test Off Load (Standard).....	74
8.10.	Load Demand Inhibit - LDI (Standard)	74
8.11.	Peak Shave - PS (Standard).....	75
8.12.	Manual Return to Normal - MRTN - (Standard).....	75
8.13.	Closed Transition Transfer - CTT (Optional)	75
8.14.	Battery Charger - BC (Optional).....	76
8.15.	Dual Prime Source - DPS (U-to-U) (Optional)	76
8.16.	Utility-to-Generator System (Standard)	76
8.17.	Generator-to-Generator System (Optional).....	76
8.18.	Multifunction Digital Meter - DM (Optional)	76
8.19.	Datalogging (Standard)	77
8.20.	Phase Sequence Monitor - PSM (Standard)	77
8.21.	Strip Heater - SH (Optional).....	77
8.22.	Single Phase Protection - SPP (Standard).....	77
9.	Appendixes	78
9.1.	Appendix A	78
9.2.	Appendix B	79
9.3.	Appendix C	80
9.4.	Appendix D	81
9.5.	Appendix E	82

Table of Figures

Figure 1 - Motor Slip Screws	13
Figure 2 - Typical Control Wire Terminals for a Utility-to-Generator Setup.....	13
Figure 3 - LSE8600 Panel Mount Dimensions	17
Figure 4 - Self Seeking Power Supply	18
Figure 5 - Self Seeking Power Supply (Typical) Wiring Diagram	18
Figure 6 - Relay Output Expansion Module - DSE2157	19
Figure 7 - DSE2157 Dimensions	19
Figure 8 - Expansion Module (Typical) Wiring Diagram.....	20
Figure 9 - DSE2130 Relay (8) Input Expansion Module	20
Figure 10 - DSE2130 Dimensions	21
Figure 11 - DSE2130 Typical Wiring 1	21
Figure 12 - DSE2130 Typical Wiring 2	22
Figure 13 - LED (8) Annunciator Expansion Module - DSE2548.....	22
Figure 14 - DSE2548 Dimensions	23
Figure 15 - DSE2548 Typical Wiring	23
Figure 16 - DSENet Login Instructions	25
Figure 17: DSENet Home Page	26
Figure 18: DSENet Module Setup	26
Figure 19: S1 Remote Control Page.....	26
Figure 20 - Top PLC Terminals	27
Figure 21 - Bottom PLC Terminals	28
Figure 22 - RS232 Pinouts - View looking into the Male Connector	29
Figure 23 - RS485 & RS232 Communication Terminals	29
Figure 21 - Editor - Display Screen.....	39
Figure 22 - Editor - Display - Current Date and Time.....	39
Figure 23 - Editor - Display Screen.....	40
Figure 24 - Editor - Timers Screen	40
Figure 25 - Editor - Display Screen.....	42
Figure 26 - Editor - Schedule.....	42
Figure 27 - Editor - Schedule - Changed to Active.....	42
Figure 28 - Bank 1 - Weekly	43
Figure 29 - Schedule Setup.....	43
Figure 30 - Example Wiring of the LSE8600 Controller	46
Figure 31 - Typical Wiring Diagram - 3 ϕ 4W	47
Figure 32 - Typical Wiring Diagram - 3 ϕ 3W	47
Figure 33 - Typical Wiring Diagram - 1 ϕ 2W	48
Figure 34 - Typical Wiring Diagram - 2 ϕ 3W (L1-L2).....	48
Figure 35 - Typical Wiring Diagram - 2 ϕ 3W (L1-L3).....	49
Figure 36 - Gear Motor Assembly	51
Figure 37 - Assembled Gear Motor	51
Figure 38 - Molded Case Unit - Internal View	52
Figure 39 - DSE Configuration Suite Icon.....	60
Figure 40 - Main Configuration Suite Software Screen.....	61

Figure 41 - LSE8600 Controller - Open Scada Information.....	61
Figure 42 - Event Log Screen.....	62
Figure 43 - Data Logging Screen.....	62
Figure 44 - DSE2130 Controls and Indications.....	64
Figure 45 - DSE2157 Controls and Indications.....	66
Figure 46 - DSE2548 Controls and Indications.....	67
Figure 47 - DSE2548 Remote Horn Silence Push Button.....	68
Figure 48 - Service Entrance Label.....	71

Table of Tables

Table 1 - Control Wire Setup.....	11
Table 2 - Enclosure NEMA Ratings Available.....	11
Table 3 - Automatic Transfer Switch Nomenclature.....	12
Table 4 - Top PLC Terminals.....	27
Table 5 - Bottom Terminals.....	28
Table 6 - RS232 Pinouts.....	28
Table 7 - RS485 Terminals.....	29
Table 8 - Communications.....	29
Table 9 - Individual Plugs.....	30
Table 10 - Spare Parts for LSE8600 Controller.....	30
Table 11 - LSE8600 Control Push-Button Descriptions.....	31
Table 12 - LSE8600 Control Push-Button Descriptions - Continued.....	32
Table 13 - Electrical Trip Example.....	35
Table 14 - Electrical Trips.....	36
Table 15 - Warnings & Reasons.....	36
Table 16 - Warnings & Reasons Continued.....	37
Table 17 - Starting.....	63
Table 18 - Loading.....	63
Table 19 - Alarms.....	63
Table 20 - Instruments.....	64
Table 21 - DSE2130 LED Indications.....	65
Table 22 - DSE2130 Fault Diagnosis.....	65
Table 23 - DSE2157 LED Indications.....	66
Table 24 - DSE2157 Fault Diagnosis.....	67
Table 25 - DSE2548 LED Indications.....	68
Table 26 - DSE2548 Fault Diagnosis.....	69
Table 27 - Ground Fault Detected - Protection.....	71
Table 28 - Ground Fault Detected - Indication.....	72
Table 29 - ACBT when Transferring to S2.....	72
Table 30 - ACBT when Transferring to S1.....	72
Table 31 - Test Off Load.....	74
Table 32 - Check Sync Transfer Timer.....	75

1. Construction

The Transfer Switches covered in this manual use molded case switches and/or circuit breakers to accomplish the transfer of two separate power sources to a single load.

These molded case circuit breaker(s) and/or switch/switches, (molded case units), are interlocked via electrical and mechanical control systems.

The LSE8600 Controller combined with the auxiliary contact switch located in the molded case unit encompasses the electrical interlock system.

The physical "Plunger Style" interlock installed between the two molded case units encompasses the mechanical interlock system. The interlock is located on the rear of the base plate and is a fulcrum and lever device, which positively prevents both molded case switches or circuit breakers from being in the **ON** position simultaneously.

The two control systems provide a redundant interlocking scheme which provides a "Fail-Safe" design. Note: This mechanical interlock is not provided on units equipped with the Closed Transition Option.

The gear motors are operated at 120Vac, supplied by the unit. The gear reduction unit is permanently lubricated so that it requires no maintenance.

All styles of transfer switches are provided with an insulated operating handle to enable personnel to manually operate the transfer switch in the event of an emergency. The handle is permanently mounted and readily accessible and allows the operator to manually operate the transfer switch under load.

All interface relays are of the enclosed industrial type to ensure long life and minimum maintenance. They are rated for continuous duty to eliminate overheating of coils.

The LSE8600 controller will provide adequate control of the Automatic Transfer Switch (ATS). These controllers offer programmable timers. Including the plant exerciser, and these values are stored in non-volatile memory.

2. Description of Operation

The following are general descriptions of operation applying to the different styles of Transfer Switches. Certain accessory additions may modify the sequence of operations as required to suit specific applications.

2.1. Single Motor Operator

The Single Motor ATS utilizes a single motor to operate both the normal and emergency molded case units. Normally, the transfer switch operates on the preferred power source with the Normal molded case unit in the closed position and the Emergency molded case unit in the open position. (Refer to Individual Unit Wiring Diagrams Included with the Transfer Switch.)

All phases of the preferred power source, S1 (typical: Utility), are continuously monitored by the voltage sensing inputs of the LSE8600 Controller. These undervoltage settings are preset to 90% pick-up and 80% drop-out of the nominal voltage. If different settings are required, please contact Lake Shore Electric for assistance in changing these settings. In the event of a drop in any phase of the preferred voltage below the dropout set point, the LSE8600 Controller will follow these steps:

1. The S1 light on the LSE8600 controller will turn off and the display will indicate a warning under the "Alarm" screen menu.
2. The "S2 Start Delay" will time for the Factory Default setting of 3 seconds. This would be the standard "Engine Generator Start Delay" time to avoid nuisance transfers.
3. Then the "S1 Return Delay" will time for the Factory Default setting of 3 seconds. This would be the standard "Time Delay to Emergency" to avoid premature loading of the generator.
4. The "NS" molded case unit will open to remove the load from S1 power source, and the "ES" molded case unit will close at the same time to connect the load to S2 power source.

NOTE: If overvoltage sensing is used, factory default settings would be 120% drop-out and 115% pick-up of nominal voltage.

The preceding sequence of operation describes the operation of a basic single motor operated, Automatic Transfer Switch (ATS). Lake Shore Electric offers a wide variety of accessory equipment to meet customer specifications. Please refer to the schematic diagram provided with your Lake Shore ATS for specific controls provided.

2.2. Dual Motor Operator

The Dual Motor Automatic Transfer Switch (ATS) operates in much the same way as described in section 2.1 Single Motor Operator with the exception that each molded case unit has its own motor operator. This allows the load to be disconnected from both the S1 and S2 power sources, offering the load a "Neutral / Off" position. When the LSE8600 sends the signal to transfer, one motor operator disconnects its source, which transfers the switch to the **open** position temporarily. Then, the LSE8600 sends the signal to the opposite motor operator, connecting the load to its source.

All phases of the preferred power source, S1 (typical: Utility), are continuously monitored by the voltage sensing inputs of the LSE8600 Controller. These undervoltage settings are preset to 90% pick-up and 80% drop-out of the nominal voltage. If different settings are required, please contact Lake Shore Electric for assistance in changing these settings. In the event of a drop in any phase of the preferred voltage below the dropout set point, the LSE8600 Controller will follow these steps:

1. The S1 light on the LSE8600 controller will turn off and the display will indicate a warning under the "Alarm" screen menu.
2. The "S2 Start Delay" will time for the Factory Default setting of 3 seconds. This would be the standard "Engine Generator Start Delay" time to avoid nuisance transfers.
3. Then the "S1 Return Delay" will time for the Factory Default setting of 3 seconds. This would be the standard "Time Delay to Emergency" to avoid premature loading of the generator.
4. The "NS" molded case unit will then be opened to remove the load from S1 source power.
5. The "Non-Sync Transfer Timer" will time for the Factory Default setting of 0 seconds. However, there is a prebuilt in timer of 3 seconds that cannot be changed below that setting for this controller. However, the delay may be increased by changing the Factory Default from 0 seconds to the desired time delay.
6. The "ES" molded case unit will then be closed to connect the load to S2 source power.

NOTE: If overvoltage sensing is used, factory default settings would be 120% drop-out and 115% pick-up of nominal voltage.

The Dual Motor ATS is used **EXCLUSIVELY FOR SERVICE ENTRANCE (SE) RATED TRANSFER SWITCHES** because the dual motor design allows for the necessary condition of having both switches in the "OFF" position so that the load is isolated and disconnected from both sources.

The Dual Motor ATS is also used **EXCLUSIVELY FOR CLOSED TRANSITION TRANSFER (CTT) SWITCHES** because the dual motor design allows for the necessary condition of having both switches in the "ON" position so that the load is momentarily connected to both sources when they are synchronized providing a "make before break" transfer.

(Refer to Individual Unit Wiring Diagrams Included with the Transfer Switch.)

The preceding sequence of operation describes the operation of a basic dual motor, ATS. Lake Shore Electric offers a wide variety of accessory equipment to meet customer specifications(s)/requirements(s). Please refer to the schematic diagram provided with your Lake Shore ATS for the specific controls provided.

NOTE: For a UTILITY TO UTILITY (Dual Prime Source) application, a preferred source selector switch is provided on all transfer switches built for Utility-to-Utility applications. The sequence of operation does not include the "S2 Start Delay" or "Engine Generator Start Delay"

3. Installation

The LSE8600 controller monitors the voltage source of both S1 and S2 directly to verify that the sources are within acceptable parameters. The ATS will not operate on a voltage other than that stamped on the nameplate of the transfer switch, so please verify the equipment received is built for the system it is being installed within.

3.1. Mounting and Connecting

The standard Lake Shore transfer switch is designed for operation in a clean, dry, dust-free location where a minimum of vibration is present.

When used in conjunction with an engine generator set, it is recommended that the transfer switch be located as close as possible to the generator set, as this will reduce the length of the DC control wiring (required for automatic operation). This will help with preventing voltage drops and improper operation. See Table 1 - Control Wire Setup for recommended ATS to Generator distances.

Table 1 - Control Wire Setup

Control Wire (See Schematic for Terminal #'s)	Max Distance	Wire Gage Size
DC Power	1400 feet	#10 awg
Engine Start Signal	1400 feet	#10 awg

Table 2 - Enclosure NEMA Ratings Available

Lake Shore Electric Enclosure Style Offerings	Ratings
Wall Mount Free Standing	NEMA 1 NEMA 3R NEMA 12 NEMA 4 NEMA 4X
Open (Customer Supplied Enclosure)	None (Customer Supplied Enclosure)

Before bringing the power cables to the enclosure, be certain that the lugs will be of the correct size. If not, different sizes may be ordered from Lake Shore Electric.

1. Lug size and arrangements may vary depending on molded case switch manufacturer.
2. Optional lug arrangements are available but must be specified at the time the transfer switch is ordered. Consult Lake Shore Electric for details.

When mounting an "Open" style transfer switch, there are certain steps which should be followed:

1. Allow adequate space for movement of the manual-operating handle.
2. Mount to a rigid framework to minimize vibration.
3. Review all electrical clearances with the enclosure door or panels closed.
4. On rear connected switches, ensure there is no strain on the studs due to improper alignment.

Table 3 - Automatic Transfer Switch Nomenclature

Nomenclature Names	Definition
ATS	Automatic Transfer Switch
NS (S1) NL1 NL2 NL3	"S1" Normal Source Molded Case Switch or Breaker "S1" Normal Source - Phase A or Line 1 Cables Connection Location "S1" Normal Source - Phase B or Line 2 Cables Connection Location "S1" Normal Source - Phase C or Line 3 Cables Connection Location
ES (S2) EL1 EL2 EL3	"S2" Emergency Source Molded Case Switch or Breaker "S2" Emergency Source - Phase A or Line 1 Cables Connection Location "S2" Emergency Source - Phase B or Line 2 Cables Connection Location "S2" Emergency Source - Phase C or Line 3 Cables Connection Location
LOAD L1 L2 L3	Load Connections Load Output - Phase A or Line 1 Cables Connection Location Load Output - Phase B or Line 2 Cables Connection Location Load Output - Phase C or Line 3 Cables Connection Location
NE GND	Neutral Cables Connection Location Ground Cables Connection Location

Once the transfer switch has been mounted to its installation location, perform initial start-up by following these steps:

1. Verify No Power from Any Source is Present. (a.k.a.: Utility, Generator or Other Source)
2. Place the "Control" key switch in the "Disable" position located on the door of the Automatic Transfer Switch (ATS).
3. Visually check the position of the operating handle(s) of the "NS" and "ES" breakers/switches. The handle(s) should be in the down position, indicating both are in the "Open" position. If they are not, place them in the down position.
4. Verify that all the motor slip screws are tight, (2 screws per motor), so that the motor(s) do not slip when they are powered up in the following sections. See Figure 1 - Motor Slip Screws for quick location reference.

[These must be checked each time maintenance is performed on the generator or at the least, yearly.]

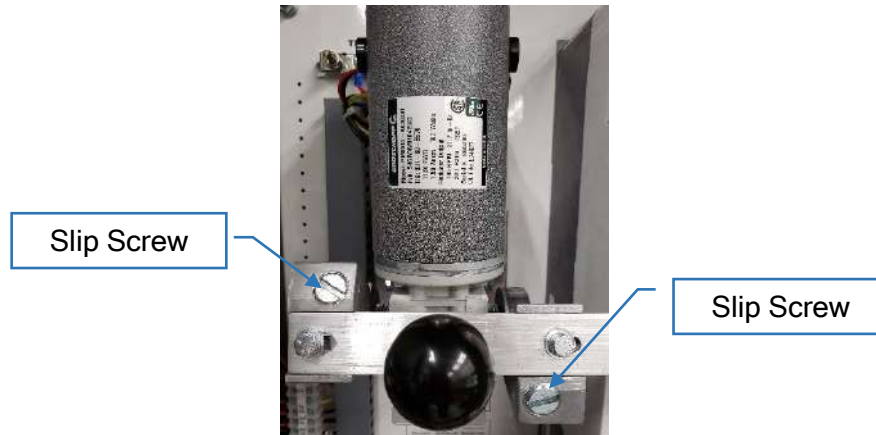

Figure 1 - Motor Slip Screws

NOTE: The maximum recommended distance the ATS should be installed from the engine generator set is 1400 feet, using #10 gage wire for all control wiring.

5. **Control Wire:** Install the DC control power wires to terminals designated on the specific units schematic drawing "XXXXXX-03" drawings. (Typical: "010 (negative)" and "011 (positive)". See Figure 2 - Typical Control Wire Terminals for reference. This number is subject to change. Please see unit drawings for specifics on current ATS.)



Figure 2 - Typical Control Wire Terminals for a Utility-to-Generator Setup

6. **Control Wire:** Connect the "Engine Start" wires to terminals designated on the specific units schematic drawing "XXXXXX-03" drawings. (Typical: "028" and "029". Utility to Generator Configuration. See Figure 2 - Typical Control Wire Terminals for reference. This number is subject to change. Please see unit drawings for specifics on current ATS.)

[Also NOTE that if this is a Generator to Generator configuration, there will be two sets of "Engine Start" contacts. If the ATS is a Utility to Utility, there will be no "Engine Start" contacts. Please see unit drawings for specifics on current ATS.]

LUG RANGE NOTE: Please refer to the outline drawing "XXXXXX-02" of the specific ATS for lug ranges for Utility, Generator and Load connections for the Power Cables.

CURRENT TRANSFORMER (CT) NOTE: Please refer to the schematic drawing "XXXXXX-03" to see if the present unit requires that monitoring CT's be included with the power cable connections and install them according to the drawing. Verify the CT's proper orientation to the current flow of the system.

7. **Power Cables:** Connect the cables from Utility to the Normal Breaker "NS". When installing the power cables, be careful not to disturb or damage the control wires that go to the various terminals.
- 3 ϕ Systems: Terminals are labeled NL1, NL2, NL3, NE and GND. **(Wye)**
 - 3 ϕ Systems: Terminals are labeled NL1, NL2, NL3 and GND. **(Delta)**
 - 1 ϕ Systems: Terminals are labeled NL1, NL2, NE and GND. **(Polyphase)**
 - 1 ϕ Systems: Terminals are labeled NL1, NE and GND. **(Single Phase)**
8. **Power Cables:** Connect the cables from Back Up Power Supply or Generator to the Emergency Breaker "ES". When installing the power cables, be careful not to disturb or damage the control wires that go to the various terminals.
- 3 ϕ Systems: Terminals are labeled EL1, EL2, EL3, NE and GND. **(Wye)**
 - 3 ϕ Systems: Terminals are labeled EL1, EL2, EL3 and GND. **(Delta)**
 - 1 ϕ Systems: Terminals are labeled EL1, EL2, NE and GND. **(Polyphase)**
 - 1 ϕ Systems: Terminals are labeled EL1, NE and GND. **(Single Phase)**
9. **Power Cables:** Connect the cables from the Load to the load lugs on the ATS. When installing the power cables, be careful not to disturb or damage the control wires that go to the various terminals.
- 3 ϕ Systems: Terminals are labeled L1, L2, L3, NE and GND. **(Wye)**
 - 3 ϕ Systems: Terminals are labeled L1, L2, L3 and GND. **(Delta)**
 - 1 ϕ Systems: Terminals are labeled L1, L2, NE and GND. **(Polyphase)**
 - 1 ϕ Systems: Terminals are labeled L1, NE and GND. **(Single Phase)**
10. **Power Cables:** Verify that the phase sequence rotation of the normal and emergency sources match and are connected to the same load connection via their respective molded case unit.
- Important Note:** Failure to do this will result in damage to the transfer switch/other equipment and will void the warranty extended by Lake Shore Electric.
11. **Power Cables:** A ground lug is provided on all transfer switches. This lug **must** be connected to earth ground.
- Caution:** Be sure to check that all power cable lugs are torqued to the applicable requirement for the switch (see Appendix B).

12. **Additional Control Wire Installation:** There are numerous accessories available on Lake Shore transfer switches which require external connections. Refer to the specific ATS unit's schematic and layout "XXXXXX-03 and XXXXXX-04" drawings for additional connections which must be made.



3.2. Placing the Transfer Switch in Operation





Before energizing the transfer switch electrically, be certain all external connections have been properly made according to the wiring diagram provided. Revisit section 3.1 Mounting and Connecting for reference.

Inspect all wires, cables, and bus bar for abraded insulation, foreign matter, and electrical clearance.

The LSE8600 controller monitors the voltage source of both S1 and S2 directly to verify that the sources are within acceptable parameters. The ATS will not operate on a voltage other than that stamped on the nameplate of the transfer switch, so please verify the equipment received is built for the system it is being installed within.

3.2.1. ATS Control Start-Up

1. Verify the DC voltage on terminals to terminals designated on the specific units schematic drawing "XXXXXX-03" drawings is available. (Typical Terminal #'s: "010 (negative)" and "011 (positive)")
 - If correct, continue to the next step.
 - If DC voltage is not present, verify the DC wiring / DC power supply for errors until the power loss cause is found.
2. Close and lock the main door of the ATS.
3. Place the **"Control"** key switch in the **"Enable"** position located on the door of the Automatic Transfer Switch (ATS).
4. The LSE8600 Controller will boot up in the  "Auto" mode.
 - a. If utility power is available, then the ATS will close the "NS" switch and connect the load to utility power.
 - b. If utility power is not available, then the ATS will start the generator, close the "ES" switch, and connect the load to generator power.
5. Once power has been applied to the ATS load and it appears to be working properly, verify that the unit is reading proper voltage on the LSE8600 S1 and S2 menus on the screen display. Use the Left / Right arrows next to the  button to view the correct menu of the source available if not already visible.
6. Use the Up / Down arrows next to the  button to scroll through S1 or S2 power readings.

7. If the voltage seen on the S1 or S2 menu screen is within the correct parameters for the source being viewed, the power cables are connected properly, and no shorting occurred, proceed to the next step. If problems occurred, please troubleshoot, as necessary.
NOTE: Typically, voltage should only be available from one of the sources at this time. However, if voltage is present on the second source, verify its voltage also.
8. If CT's were connected during installation, the current measurements may be verified from the S1 and S2 menus also. Look at the LSE8600 LED indicators to determine which source is feeding the load, then navigate to the proper menu on the LSE8600 controller.
9. To perform a load test, press the  "Mode" button on the front of the LSE8600 controller.
10. Depending on the last option selected, there are three text strings that could start blinking at the top of the screen.
 - a. Test On Load
 - b. Test Off Load
 - c. Prohibit Return
11. Press the  "Mode" button to scroll through those options until "Test On Load" is blinking at the top of the screen.
12. Press the  button to select and the LSE8600 controller will transfer the load from source S1 to source S2.
13. Listen for the motor operators to change state; first opening "NS" then closing "ES".
14. The LED lights on the front of the LSE8600 should confirm the opening of S1 and closing of S2 to the load.
15. To end the load test, press the  "Auto" button and the system will return the ATS load to source S1.
16. The engine cool down timer will keep the generator running until its timing sequence has completed.
17. The above instructions are enough to place the ATS in service and it is now operational.

The following pages contain specific information on the various components and troubleshooting information.

4. Controller LSE8600

4.1. Introduction

The LSE8600 is a Programmable Logic Controller (PLC) based Automatic Transfer Switch (ATS) controller.

It consists of four major parts:

1. Self-Seeking Power Supply (SSPS)
2. Expansion Modules (EMs)
3. LSE8600 Controller - Rear Controls (HMI)
4. LSE8600 Controller - Front Controls (HMI)

It is designed to operate in the temperature range of -22 °F to +158 °F (-30 °C to +70 °C); storage temperatures of -40 °F to +176 °F (-40 °C to +80 °C)

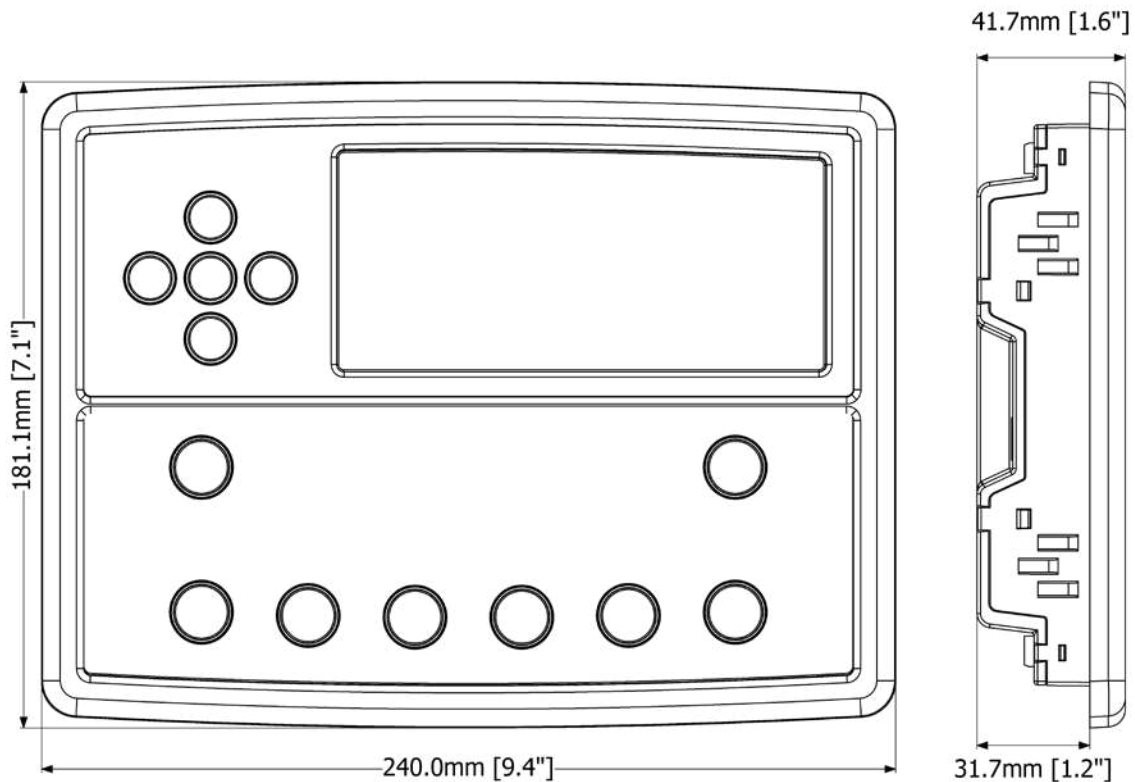

Figure 3 - LSE8600 Panel Mount Dimensions

4.1.1. Self-Seeking Power Supply

This is an optional accessory that may be provided for a unit. Please see unit specific drawings if purchased.



Figure 4 - Self Seeking Power Supply

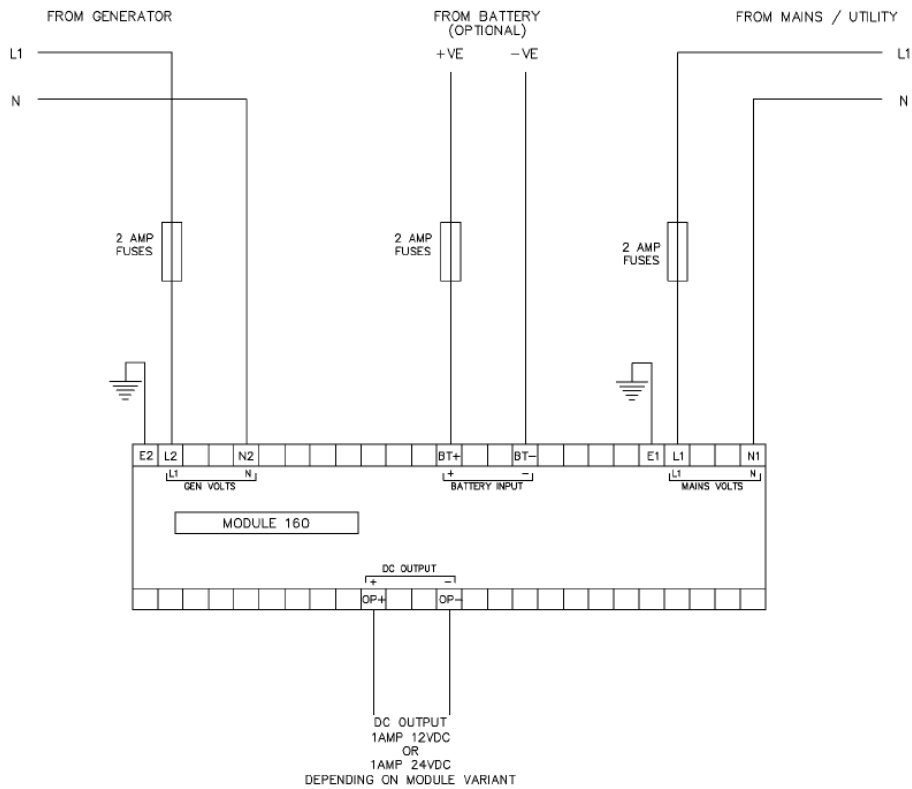

Figure 5 - Self Seeking Power Supply (Typical) Wiring Diagram

4.1.2. Expansion Modules

4.1.2.1. Relay (8) Output Expansion Module - DSE2157

This is an optional accessory that may be provided for a unit. Please see unit specific drawings if purchased.

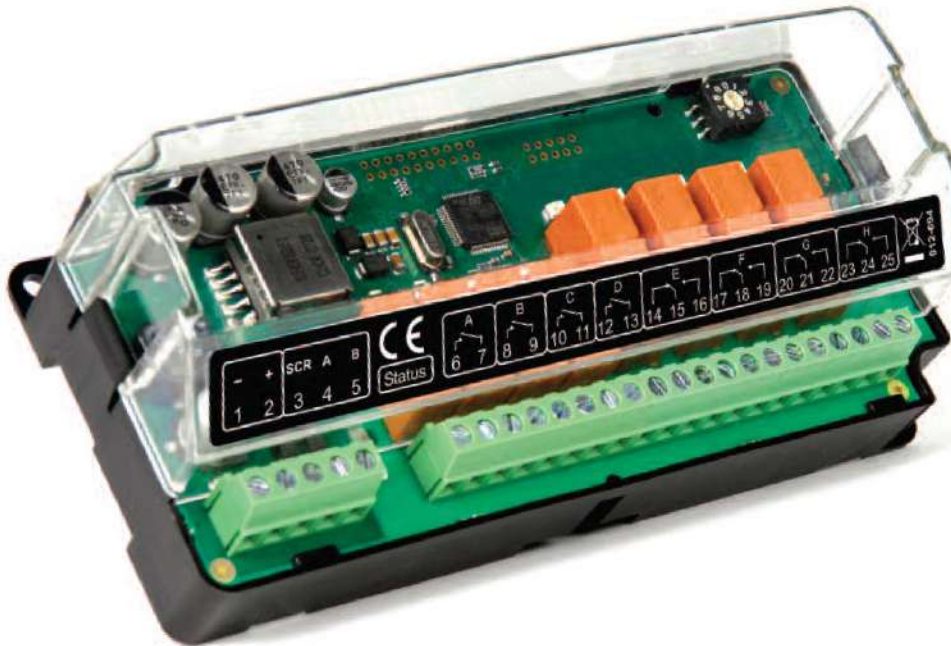
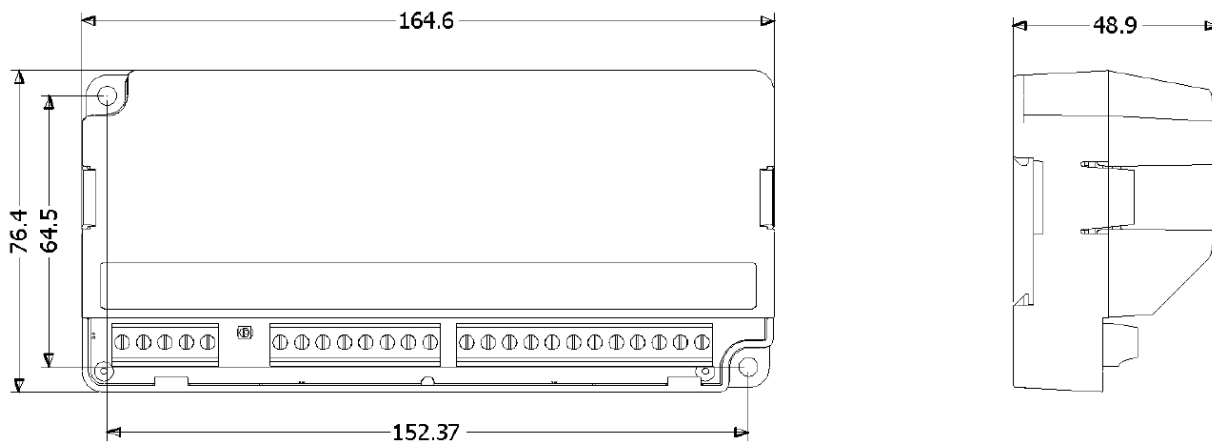

Figure 6 - Relay Output Expansion Module - DSE2157



Dimensions in mm

Figure 7 - DSE2157 Dimensions

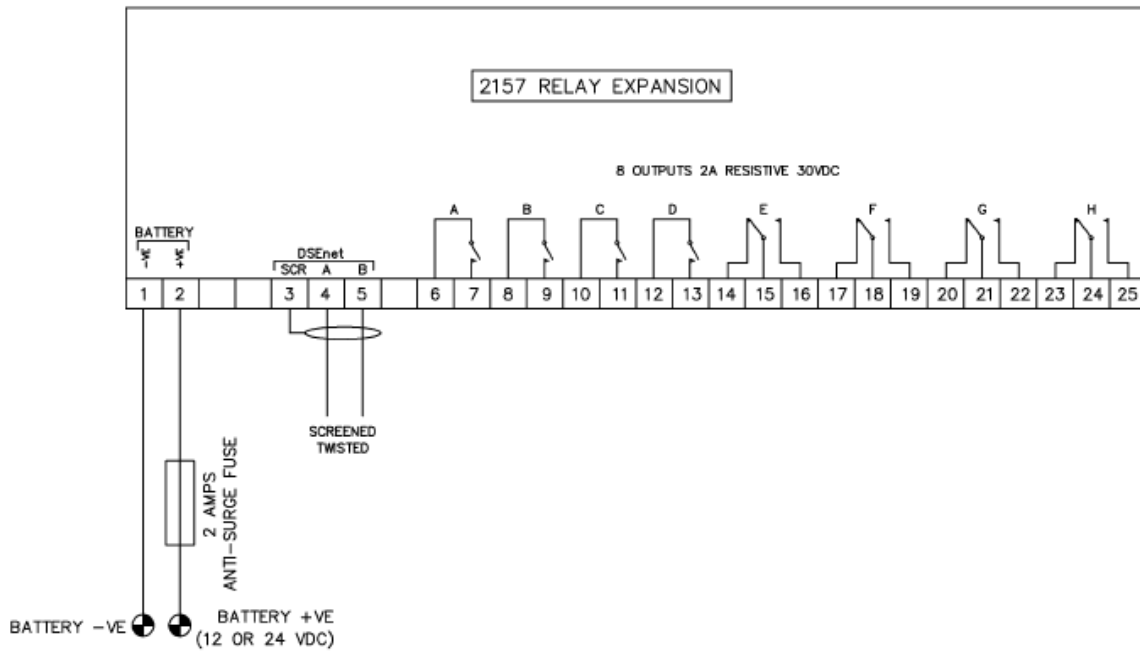

Figure 8 - Expansion Module (Typical) Wiring Diagram

4.1.2.2. Relay (8) Input Expansion Module - DSE2130

This is an optional accessory that may be provided for a unit. Please see unit specific drawings if purchased.



Figure 9 - DSE2130 Relay (8) Input Expansion Module

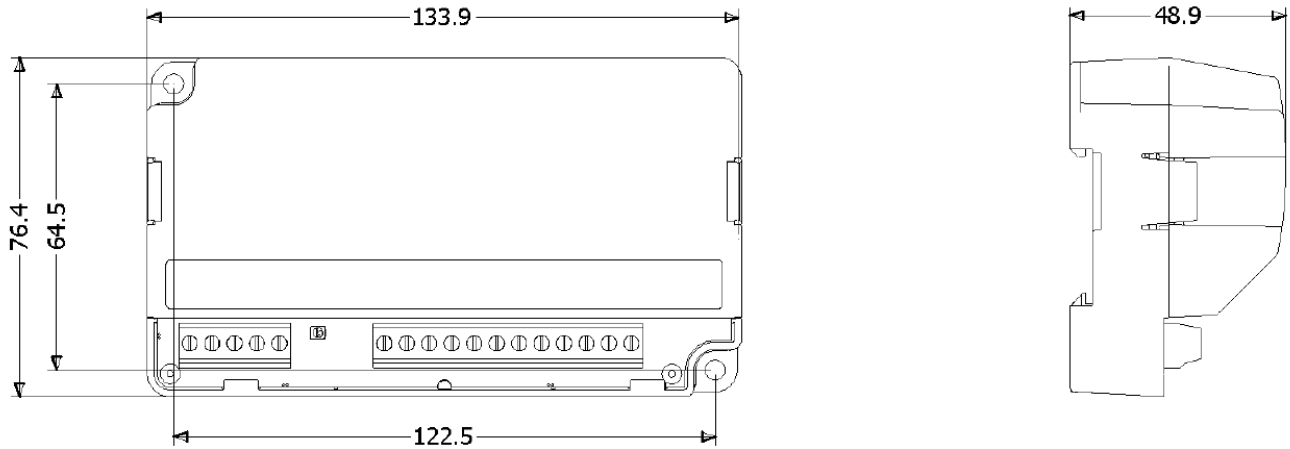

Dimensions in mm

Figure 10 - DSE2130 Dimensions

2130 SHOWN CONNECTED AS 4 DIGITAL INPUTS AND 4 ANALOGUE INPUTS

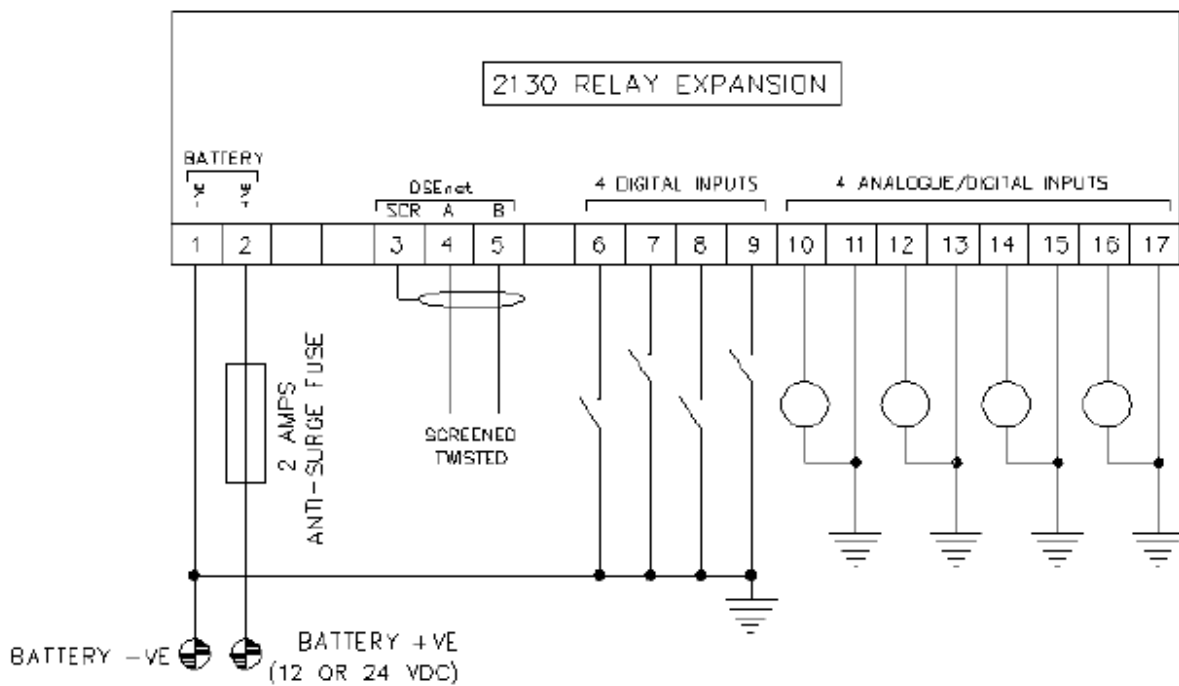

Figure 11 - DSE2130 Typical Wiring 1

2130 SHOWN CONNECTED AS 8 DIGITAL INPUTS

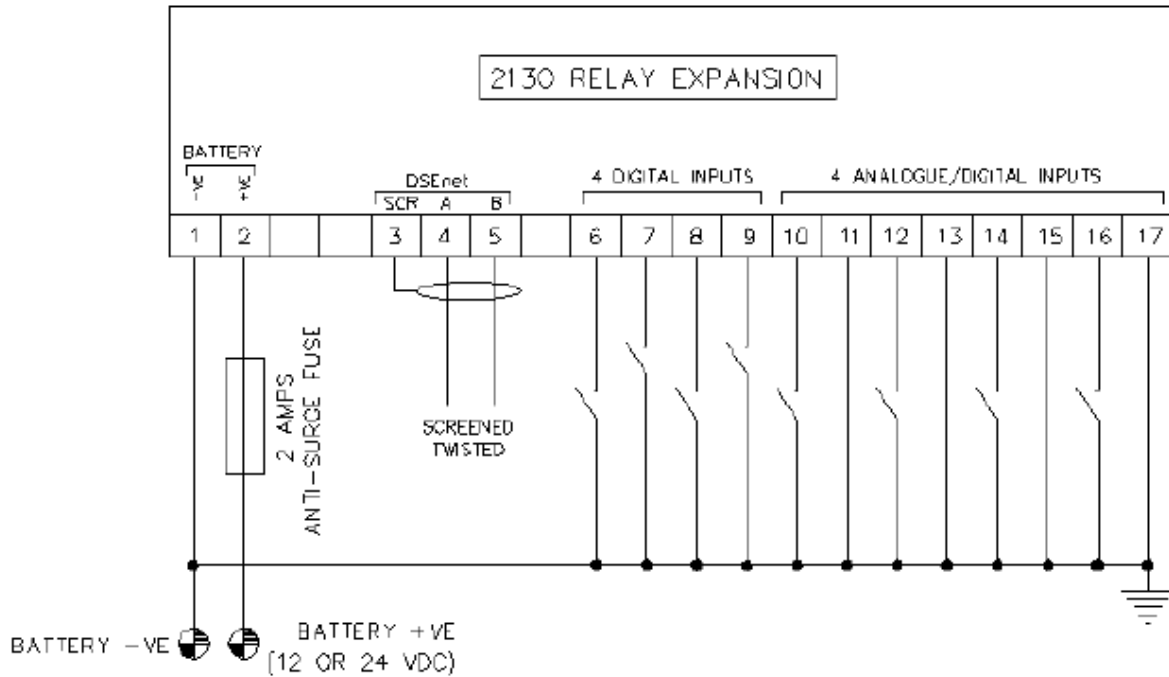

Figure 12 - DSE2130 Typical Wiring 2

4.1.2.3.LED (8) Annunciator Expansion Module-DSE2548

This is an optional accessory that may be provided for a unit. Please see unit specific drawings if purchased.



Figure 13 - LED (8) Annunciator Expansion Module - DSE2548

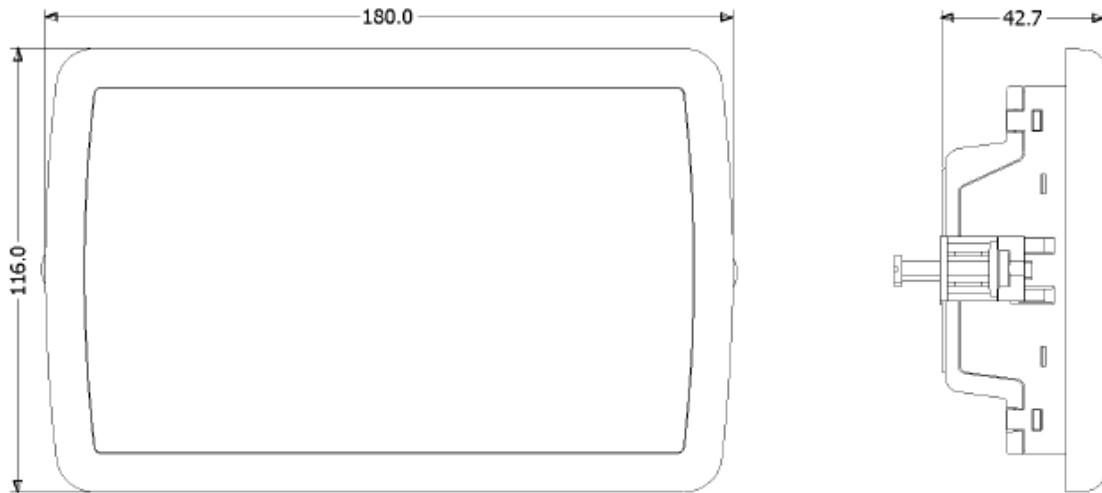

Dimensions in mm

Figure 14 - DSE2548 Dimensions

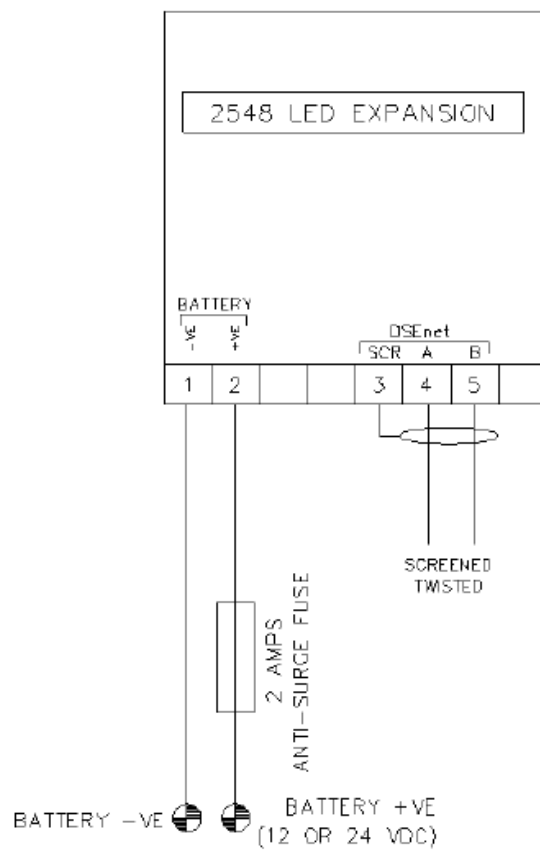

Figure 15 - DSE2548 Typical Wiring

4.1.2.4. Ethernet Communication Module - DSE89x

This module is an RS-485 modbus upgrade to ethernet modbus protocols. This also offers a remote connection to the 8600 controller for remote ATS control. This is an optional accessory that may be provided for a unit. Please see unit specific drawings if purchased.

If included with the ATS, please see instructions below for remote connection.

1. Make an account on <https://www.dsewebnet.com/>
2. Click on “Manage Gateways and Modules”
3. Search the device using the USB Gateway ID. This is a 15-character number located on the right-hand side of the 89x controller.
4. Enter the password “Password1234” when prompted.
5. Once the device is added, return to the home page and data will be available to monitor from the ATS.
6. To change this password please see the quick start-up guide linked on the “Gateways and Modules” page.
7. See Figure 16 - DSENet Login Instructions for additional information.
8. See Figure 17: DSENet Home Page below for how to access controller data.

NOTE: To access DSEWebNet®, a user account is required. For further details on how Register and Login to DSEWebNet®, refer to DSE Publication: 057-168 DSEWebNet® PC Internet Browser Software Manual.

To add a DSEGateway® to the user's account, the Gateway USB ID and Security Code are required. This information is located in the DSEGateway® Status Configuration screens.

The DSEGateway® USB ID is located under the *Status Info* section of the DSEGateway® configuration.

The Security Code is located under the *Configuration Info* section of the DSEGateway® configuration.

1. Launch a compatible internet browser and navigate to the website: www.dsewebnet.com and login into DSEWebNet®.
2. Click on *Manage Gateways and Modules* located on the top right hand corner of the webpage. The *Devices* section of the *Account Settings* is opened.
3. To add a DSEGateway® to the account, click the *Plus* button located on the top right hand corner of the webpage. The *Add New Gateway* option is opened



4. Enter the DSEGateway® USB ID and Password

Click to continue

5. Select the Module to be added. DSEWebNet® uses the Module's *USB ID*.

Select the DSE Module(s) to be added to the DSEWebNet®.

Enabled	Module USB ID	Name
<input checked="" type="checkbox"/>	213657710	
<input checked="" type="checkbox"/>	213AE33CA	Gen 1
<input checked="" type="checkbox"/>	213AE348A	Gen 2
<input checked="" type="checkbox"/>	6JFFF713D	Gen 3
<input type="checkbox"/>	3194EE0D4	3194EE0D4
<input type="checkbox"/>	31F61C26D	31F61C26D
<input type="checkbox"/>	618D04F73	618D04F73

USB ID of the DSE Module(s) that are, or have been connected to the DSEGateway®

Save the changes that have been made

Figure 16 - DSENet Login Instructions



Figure 17: DSENet Home Page

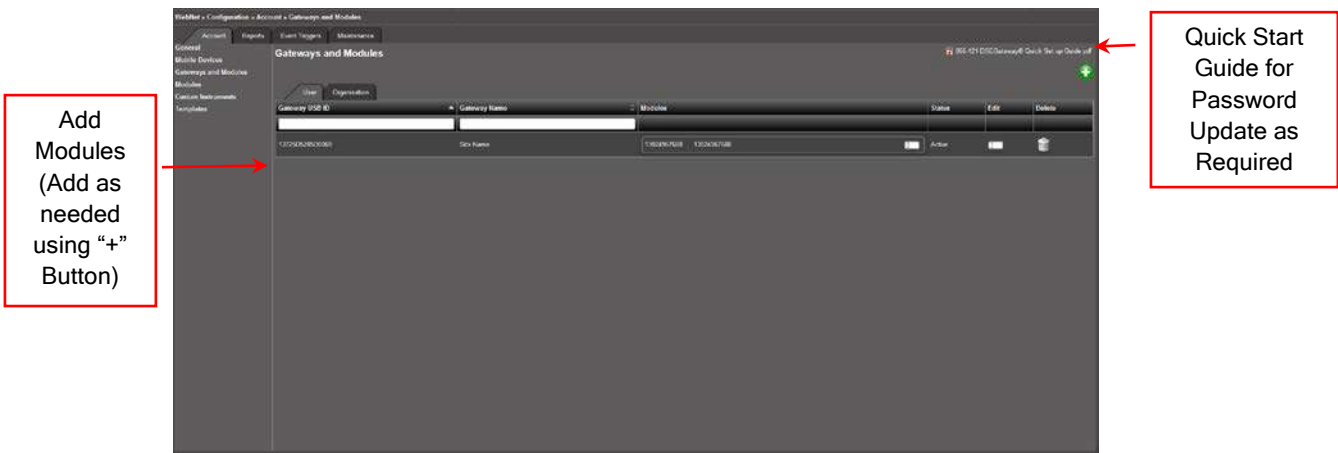

Figure 18: DSENet Module Setup

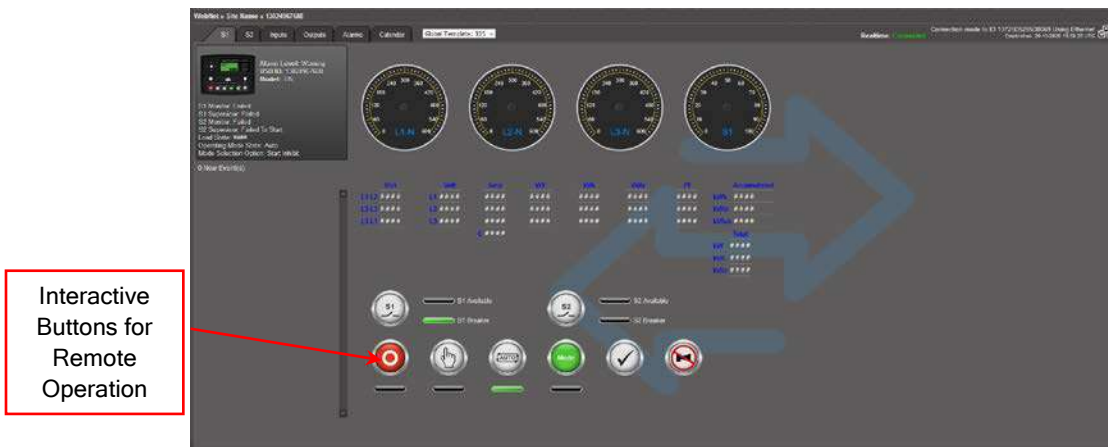

Figure 19: S1 Remote Control Page

4.1.3. LSE8600 Controller - Rear Controls (HMI)

The programmable logic controller (PLC) contains the controls and performs all the logic necessary to control the transfer switch. It contains the current date and time when shipped from the factory but must be manually updated for day light savings time twice a year. It contains the timers listed in the section marked “Setting Timers”. All timers, date & time settings are stored in non-volatile memory, with battery backup, which can be maintained de-energized for up to 10 years.

There are no user serviceable components in the PLC. All these connections are made at the factory. There is only one connection to be made to the PLC in the field (if available). That is for connection of an audible alarm when an alarm occurs. This connection is always made to Output "A" contact on the PLC. Reference Figure 20 - Top PLC Terminals and Table 4 - Top PLC Terminals for output contact location.

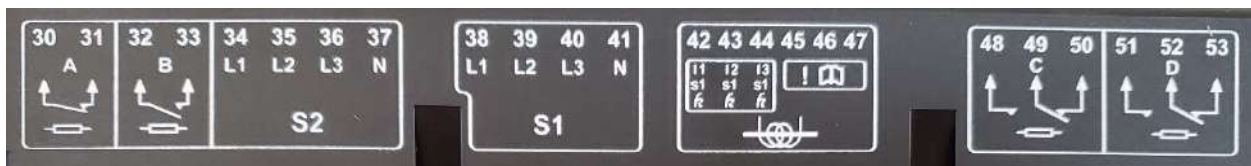

Figure 20 - Top PLC Terminals

Table 4 - Top PLC Terminals

Terminal Number	Connection Type	Terminal Label	Description
30	Common	A	Form "B" Contact
31	Normally Closed		
32	Common	B	Form "A" Contact
33	Normally Open		
34	S2 Voltage Input	L1	Phase A
35		L2	Phase B
36		L3	Phase C
37		N	Neutral
38		L1	Phase A
39	S1 Voltage Input	L2	Phase B
40		L3	Phase C
41		N	Neutral
42	Load Current Input	I1	Load Current Phase 1
43		I2	Load Current Phase 2
44		I3	Load Current Phase 3
45	N/A	N/A	Not Used
46	Load Current Common	N/A	Load Current Common
47	N/A	N/A	Not Used
48	Normally Open	C	Form "C" Contact
49	Common		
50	Normally Closed		
51	Normally Open	D	Form "C" Contact
52	Common		
53	Normally Closed		



Figure 21 - Bottom PLC Terminals

Table 5 - Bottom Terminals

Terminal Number	Connection Type	Terminal Label	Description
1	Battery (-)	-	Battery (-) Input
2	Battery (+)	+	Battery (+) Input
3	Output	G	Mosfet Output
4	Output	H	Mosfet Output
5	Output	I	Mosfet Output
6	Output	J	Mosfet Output
7	Output	K	Mosfet Output
8	Output	L	Mosfet Output
9	Input	A	Mosfet Input
10	Input	B	Mosfet Input
11	Input	C	Mosfet Input
12	Input	D	Mosfet Input
13	Input	E	Mosfet Input
14	Input	F	Mosfet Input
15	Input	G	Mosfet Input
16	Input	H	Mosfet Input
17	Input	I	Mosfet Input
18	Input	J	Mosfet Input
19	Input	K	Mosfet Input
20	Input	L	Mosfet Input
21	Communication	B	Data +
22	Communication	A	Data -
23	Communication	SCR	Shield Ground
24	N/A	N/A	Not Used
25	Common	E	Form "B" Contact
26	Normally Closed		
27	N/A	N/A	Not Used
28	Common	F	Form "A" Contact
29	Normally Open		

Table 6 - RS232 Pinouts

Pin No.	Notes
1	Received Line Signal Detector (Data Carrier Detect)
2	Received Data
3	Transmit Data
4	Data Terminal Ready
5	Signal Ground
6	Data Set Ready
7	Request To Send
8	Clear To Send
9	Ring Indicator

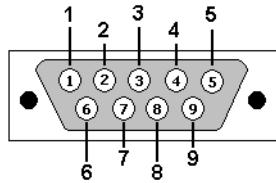

Figure 22 - RS232 Pinouts - View looking into the Male Connector

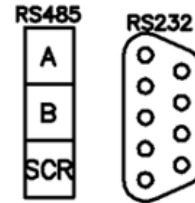

Figure 23 - RS485 & RS232 Communication Terminals

Table 7 - RS485 Terminals

Pin No.	Notes	Description
1	A	Data (A) -
2	B	Data (B) +
3	SCR	Twisted Pair Communication Wire Shield

Table 8 - Communications

Symptom	Possible Remedy
RS485 inoperative	Check : <ul style="list-style-type: none"> • Connection cable – Belden 9841 or equivalent • 120 Ω termination resistors are correctly fitted • Baud rate of controller and of master device are the same • Slave ID of the controller is the same as configured in the master device
RS232 connection to PC inoperative	Check : <ul style="list-style-type: none"> • RS232 maximum of 15 m is not exceeded • Direct to PC connection requires a Crossover (NULL modem) RS232 cable • Baud rate of controller and of master device are the same • Slave ID of the controller is the same as configured in the master device
RS232 connection to GSM modem inoperative	Check : <ul style="list-style-type: none"> • RS232 maximum of 15 m is not exceeded • Modem Initialization strings in the DSE configuration is correct for the connected modem type • Modem is configured to 9600 baud • SIM card is CSD (circuit switched data) compatible • SIM card is not PIN locked • SIM card is correctly inserted • Antenna is correctly installed and is not inside an earthed metal cabinet / control panel • A good signal is available in the locality
RS232 connection to landline modem inoperative	Check : <ul style="list-style-type: none"> • RS232 maximum of 15 m is not exceeded • Modem Initialization strings in the DSE configuration is correct for the connected modem type • Modem is configured to 9600 baud

Table 9 - Individual Plugs







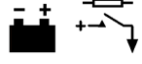
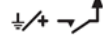

Module Terminal Designation	Plug Description	Part No.
1-8	 8 way 5.08 mm	007-164
9-17	 9 way 5.08 mm	007-167
18-24	 7 way 5.08 mm	007-447
25-29	 5 way 7.62 mm	007-473
30-37	 8 way 7.62 mm	007-454
38-41	S1 4 way 7.62 mm	007-171
42-47	 6 way 5.08 mm	007-446
48-53	 6 way 7.62 mm	007-162
	RS485 3 way 5.08 mm	007-174

Table 10 - Spare Parts for LSE8600 Controller

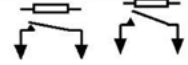
Item	Description	Part No.
	Module fixing clips (packet of 4)	020-294
	Module silicon sealing gasket	020-507
	Pack of Replacement Plugs (Full Kit)	007-827

4.1.4. LSE8600 Controller - Front Controls (HMI)

The HMI Panel consists of a graphic overlay which displays a one-line representation of a transfer switch, various LED's to annunciate status of the switch, a four line, back lit, 92-character LCD to display information about the Automatic Transfer Switch (ATS). The control buttons shown on the front display of the HMI are explained in Table 11 - LSE8600 Control Push-Button Descriptions and Table 12 - LSE8600 Control Push-Button Descriptions - Continued.

Table 11 - LSE8600 Control Push-Button Descriptions























Icon	Description
	<p>Stop / Reset</p> <p>This button places the module into its <i>Stop / Reset</i>  mode. This clears any alarm conditions for which the triggering criteria have been removed. If S2 is on load and the module is placed into Stop mode, the module automatically instructs the changeover device to unload the S2 source (<i>Close S2 Output</i> becomes inactive (if used)). If S2 is configured for a generator, the start signal given to the generator controller is also removed. If a <i>Remote Start</i> signal is present while operating in this mode, the remote start does <u>not</u> occur.</p> <p>IMPORTANT NOTE: If S1 is available, it will connect the load to source S1.</p>
	<p>Manual</p> <p>This button places the module into its <i>Manual</i>  mode to allow manual control of the ATS functions. This starts S2 when configured as a generator and runs it off load.</p>
	<p>Auto</p> <p>This button places the module into its <i>Auto</i>  mode. This mode allows the module to control the function of S1 and S2 automatically. The module monitors the <i>remote start</i> input and S1 supply status and once a start request is made, a start request is given to S2 if configured to a generator and once available, placed on load.</p> <p>Upon removal of the starting signal, the module automatically transfers the load from S2 and remove the start signal to the generator observing the <i>return delay</i> timer and <i>cooling</i> timer as necessary. The module then waits for the next start event.</p>
	<p>Mode</p> <p>This button allows the user to cycle through different operating <i>Mode</i>  and press the  button to accept the mode change.</p> <p>The modes available are:</p> <p><i>Test On Load:</i> This mode allows the module to start and load S2 for test purposes.</p> <p><i>Test Off Load:</i> This mode allows the module to start S2 and leave off load for test purposes.</p> <p><i>Prohibit Return:</i> This mode is used to prevent the module from returning load the S1 until instructed.</p>

Table 12 - LSE8600 Control Push-Button Descriptions - Continued

Icon	Description
	<p>Mute / Lamp Test</p> <p>This button silences the audible alarm if it is sounding and illuminates all the LEDs as a lamp test feature.</p>
	<p>Latest Transfer Information</p> <p>When this button is pressed, the module displays the reason, time, date and duration for the latest transfer that occurred, holding this button cycles between the last S1 transfer and the last S2 transfer.</p>
	<p>Close / Open to S1</p> <p>NOTE: This button only operates in manual mode; or to bypass the S2 Return Delay Timer and Immediately connect the Load to S1 in Auto Mode.</p> <p>Pressing the <i>Close / Open S1</i>  button when S1 is on load, opens the S1 load switch.</p> <p>Pressing the <i>Close / Open S1</i>  button when S2 is on load and S1 is within parameters, the S2 load switch opens, wait for the duration of the <i>transfer delay</i>, then closes the S1 load switch.</p>
	<p>Close/Open to S2</p> <p>NOTE: This button only operates in manual mode.</p> <p>Pressing the <i>Close / Open S2</i>  button when S2 is on load, opens the S2 load switch.</p> <p>Pressing the <i>Close / Open S2</i>  button when S1 is on load and S2 is within parameters, the S1 load switch opens, wait for the duration of the <i>transfer delay</i>, then closes the S2 load switch.</p>
	<p>Menu navigation</p> <p>Used for navigating the instrumentation, event log and configuration screens.</p> <ul style="list-style-type: none">  Check Button - Used for programming and to finalize a selection.  Up-arrow Button - Used to scroll through a menu selected or options to be edited.  Left-arrow - Used to scroll to the required menu or selection.  Down-arrow - Used to scroll through a menu selected or options to be edited.  Right-arrow - Used to scroll to the required menu or selection.

There are a total of eight (8) menus that may be viewed from the HMI display. They are displayed in the following order:

1. **Status** - Shows current status of the ATS and any voltage reading seen on the Source, S1 or S2, feeding the load.
2. **S1** - Source S1 Readings
3. **S2** - Source S2 Readings
4. **Module** - Shows the Sources Connected to the ATS, Current Date and Time and Battery Voltage Reading of Connected DC Power Supply if not using the SSPS.
5. **Alarms** - This will show all current alarms seen by the LSE8600 controller.
6. **Event Log** - This will show all current events stored by the LSE8600.
7. **Serial Port** - This shows the communication setup of the LSE8600 and current Slave ID of the RS232 com port.
8. **About** - This shows configuration information on the current application firmware installed on the LSE8600 controller, plus additional information.

Sub-Menu Information Displayed

NOTES: General Information

1. Use the Down-arrow Located in the Navigation Push-Button Section to Increment to Next Screen.
2. Auto-Scroll is Enabled for all screens. Once a menu has been selected, the display will auto-scroll through each screen within the menu in 5 second increments, factory default time, unless this feature needs to be temporarily disabled by pressing the Up-arrow key in the Navigation Push-Button section.

Status - Current ATS Connections, Events and Voltage Readings

1. Main Summary (Backup Source)
2. Main Summary (Primary Source)
3. S1 and S2 Voltage, Current and Frequency Readings
4. Supervisors Summary
5. Monitors Summary

S1 - Source S1

1. S1 Setup - Source Type & Name
2. S1 State - Information on S1 Source
3. S1 - L-N Voltage (V), L-L Voltage (V), Frequency (Hz), Power (kW) and Power Factor (pf) Readings
4. S1 Voltage - L1-N Voltage (V), L2-N Voltage (V), L3-N Voltage (V)
5. S1 Voltage - L1-L2 Voltage, L2-L3 Voltage, L1-L3 Voltage
6. S1 Frequency - Frequency (Hz)

S2 - Source S2

1. S2 Setup - Source Type & Name
2. S2 State - Information on S2 Source
3. S2 - L-N Voltage (V), L-L Voltage (V), Frequency (Hz), Power (kW) and Power Factor (pf) Readings
4. S2 Voltage - L1-N Voltage (V), L2-N Voltage (V), L3-N Voltage (V)
5. S2 Voltage - L1-L2 Voltage, L2-L3 Voltage, L1-L3 Voltage
6. S2 Frequency - Frequency (Hz)

Module - Specific Settings to Current LSE8600 Controller

1. S1 - Source Type & Name
2. S2 - Source Type & Name
3. Current Date & Time
4. Battery Voltage

Alarms - Specific Alarms Seen by LSE8600 Controller

1. Screens will depend on the total number of alarms detected and recorded by the LSE8600 controller. There will be a X/Y number in the top left corner of the display screen that will indicate the total number of alarms recorded "Y" and the current alarm being displayed "X".

Event Log - Specific Events Recorded by the LSE8600 Controller

1. Screens will depend on the Events recorded by the LSE8600.
2. Scroll through them manually or allow the auto-scroll feature to increment the screens.

Serial Port - Specific Information Regarding the LSE8600 Controller Communication Setup

1. Screen 1 - Shows Baud Rate and Slave ID

About - Firmware Version Information

1. Screen 1 - Variant (335), Application (Firmware Version), USB ID (Unique to LSE8600)
2. Screen 2 - Bootloader (Firmware Version), Analogue (Firmware Version)

4.2. Operational Configuration

The LSE8600 controls the operation of the automatic transfer switch and contains as standard features, four modes of operation, up to 9 timers with additional fixed PLC timers determined by system requirements, a plant exerciser scheduler, and various sets of dry contacts for the customers' use. (Typical Contacts: Switch Position, Source Available, Engine Start, Elevator Control and System Alarm)

4.2.1. Modes of Operation (Utility to Generator)

There are five modes of operation. All may be accessed from the HMI Panel.

1. Automatic
2. Manual
3. Load Test
4. Off / Reset
5. Alarm
 - a. Electrical Trip
 - b. S1 / S2 Failed to Open
 - c. S1 / S2 Failed to Close
 - d. S1 / S2 Closed Simultaneously (Not Physically Possible when Mechanical Interlock is Installed. However, the controller inputs may have experienced a fault if this fault is seen.)
 - e. Warnings - Non-Critical Alarm Conditions

The fifth mode is not selectable. In the LSE8600 controller, an "Electrical Trip" alarm indicates an electrical fault has occurred on the system and has locked out the LSE8600 from performing any other functions until what caused the fault has been cleared.



Any alarms that may occur during normal operation of the ATS will appear on the Alarms menu.

4.2.2. Electrical Trips

Electrical trips are "latching unload" and stop S2 (if configured as a generator) but in a controlled manner. On initiation of the electrical trip condition the module de-energizes the **"Close S2 Output"** to remove the load from S2. Once this has occurred the module starts the Cooling timer and allow the generator to cool down and shut off. The alarm must be accepted and cleared, and the fault removed to reset the module; possible power cycle may be required to complete clear the fault in the LSE8600.

Table 13 - Electrical Trip Example

1/2 Alarm
"ES" Breaker Tripped Latched Electrical Trip

Electrical trips are latching alarms and unload and stop S2 (if configured as a generator). To clear these alarms, the **STOP**  button is pressed. If the LSE8600 does not go back to the "Auto" mode when the  button is pushed, the controller needs to be power cycled.

Turn off the control power for a count of 3 seconds, then turn it back on. All faults will have been cleared, but if the controller is still experiencing errors, please call Lake Shore Electric at the phone number indicated on the front cover of this manual.

Table 14 - Electrical Trips

Display	Reason
Auxiliary Inputs	If an auxiliary input has been configured as an electrical trip, the appropriate LCD message is displayed and the COMMON ALARM LED illuminates.
Expansion Inputs	If an expansion input has been configured as an electrical trip, the appropriate LCD message is displayed and the COMMON ALARM LED illuminates.
PLC Functions	If a PLC Function has been configured as an electrical trip, the appropriate LCD message is displayed and the COMMON ALARM LED illuminates.
S1 Breaker Auxiliary Fail	Indicates that the <i>S1 Closed Auxiliary</i> input has not activated along with the <i>Close S1 Output</i> or <i>Open S1 Output</i> , or the input has activated when the output was not energized.
S1 Phase Rotation	The module has detected a wrong phase sequence for S1.
S2 Failure Unlatched	The module has detected that S2 has failed for either an under/over voltage/frequency condition. The unlatched alarm is automatically cleared upon S2 returning to an available state.
S2 Phase Rotation	The module has detected a wrong phase sequence for S2.

4.2.3. Warnings

By default, warning alarms are self-resetting when the fault condition is removed. However, some warning alarms are latched and need to be reset manually.

Table 15 - Warnings & Reasons

Display	Reason
Auxiliary Inputs	If an auxiliary input has been configured as a warning the appropriate LCD message is displayed and the COMMON ALARM LED illuminates.
Battery Under Voltage	The DC supply has fallen below the low volts setting level for the duration of the low battery volts timer
Battery Over Voltage	The DC supply has risen above the high volts setting level for the duration of the high battery volts timer
Calibration Lost	The module has lost its calibration settings and must be sent back to DSE to be recalibrated.
Expansion Inputs	If an expansion input has been configured as a warning the appropriate LCD message is displayed and the COMMON ALARM LED illuminates.
Fail To Start	S2 has not reached the configured limits or loading voltage and frequency before the S2 Fail Delay timer has expired.
Fail To Stop	The module has detected a condition that indicates that S2 is present when it has been instructed to stop.

Table 16 - Warnings & Reasons Continued

Display	Reason
Loading Voltage Not Reached	Indicates that the S2 voltage is not above the configured <i>loading voltage</i> . S2 does not take load when the alarm is present after the safety timer. NOTE: Only applicable when S2 is configured as a generator supply.
Loading Frequency Not Reached	Indicates that the S2 frequency is not above the configured <i>loading frequency</i> . S2 does not take load when the alarm is present after the safety timer. NOTE: Only applicable when S2 is configured as a generator supply.
PLC Functions	If a PLC Function has been configured as a warning the appropriate LCD message is displayed and the COMMON ALARM LED illuminates.
S1 Breaker Auxiliary Fail	Indicates that the <i>S1 Closed Auxiliary</i> input has not activated along with the <i>Close S1 Output</i> or <i>Open S1 Output</i> , or the input has activated when the output was not energized.
S1 Failure Unlatched	The module has detected that S1 has failed for either an under/over voltage/frequency condition. The unlatched alarm is automatically cleared upon S1 returning to an available state.
S1 Phase Rotation	The module has detected a wrong phase sequence for S1.
S2 Breaker Auxiliary Fail	Indicates that the <i>S2 Closed Auxiliary</i> input has not activated along with the <i>Close S2 Output</i> or <i>Open S2 Output</i> , or the input has activated when the output was not energized.
S2 Failure Unlatched	The module has detected that S2 has failed for either an under/over voltage/frequency condition. The unlatched alarm is automatically cleared upon S2 returning to an available state.
S2 Phase Rotation	The module has detected a wrong phase sequence for S2.

4.2.4. LED Indicators on HMI Screen

There are four standard LED lights located on the top right side of the 8600 controller. These lights are as follows:

1. Not in Auto: This indicates that the system has been removed from “Auto”, either by user request or a system failure has occurred.
2. Load Demand Inhibit: This is a remote input from the customer indicating the 8600 needs to transfer the load back to S1 power and will force the load off S2 power regardless if S1 is available or not.
3. S1 Failed in Last 72 Hours: This light indicates that the system has lost utility power sometime within the last 72 hours of operation. Check the event logs to see what time this occurred.
4. Generator Exercising: This light turns on when the 8600 controller has sent a signal to the generator to run for a pre-determined amount of time setup by the system operator.

4.2.5. Accessing Editor With a Pin

Press and hold the *Stop*  and  buttons simultaneously to enter the editor.



If a module security PIN has been set, the PIN number request is then shown:

Press the  button, the first '#' changes to '0'. Press  (up or down) to adjust it to the correct value.

Press  (right) when the first digit is correctly entered. The digit entered is now shown as '#' for security.

Repeat this process for the other digits of the PIN number. Press  (left) to move back and adjust one of the previous digits.

When the  button is pressed **twice** after editing the final PIN digit, the PIN is checked for validity. If the number is not correct, re-enter the PIN.

If the PIN has been successfully entered (or the module PIN has not been enabled), the editor is displayed:

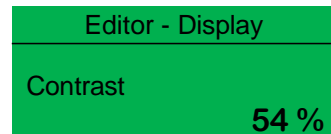

IMPORTANT NOTE: The PIN number is not set by LSE when the ATS leaves the factory. If the module has a PIN code set, this has been done by the Customer. They should have documented the change and be able to supply the code when required. If the code has been 'lost' or 'forgotten', the module must be returned to the LSE factory and the LSE8600 will be replaced. There is a charge for this procedure.

IMPORTANT NOTE! "DO NOT LOSE YOUR 4 DIGIT PIN CODE!" ONCE THIS CODE IS SET, IT MAY NOT BE REMOVED OR CHANGED WITHOUT THE CODE.

Operational Note: To remove the PIN, re-open the configuration suite software and connect via USB cable to the 8600 Controller. Go to the Scada data, =>Maintenance, =>Module Pin and set it to all zero's, then press "Set PIN". This will remove any PIN from the 8600 Controller.

4.2.6. ATS Time & Date Change



1. To get to the editor screen to view timer settings, press the  and  buttons at the same time. The screen will display "Editor - Display" at the top once in Editor Mode.

Figure 24 - Editor - Display Screen









2. Press the Down arrow under to the  button until the screen shown in Figure 25 - Editor - Display - Current Date and Time is seen.



Figure 25 - Editor - Display - Current Date and Time

3. Press the  button and the :01 text for the "Seconds" setting will start blinking.
4. Press the Up / Down Arrow Keys next to the  button to change the "Seconds" setting.
5. Press the Left Arrow Key next to the  button to increment to the "Minutes" setting.
6. Repeat steps 4 and 5 to adjust the following "Minutes", "Hour", "Year", "Month" and "Day" settings.
7. Press the  button to select changes.
8. To exit Editor Mode, press the  and  button at the same time for approximately 5 seconds. The screen will then display "Status" at the top of the screen, then return to source display screen.
9. Press the "Auto"  button to place the ATS back in "Auto" mode.

4.2.7. ATS Timer Settings & Adjustments from LSE8600 Display



1. To get to the editor screen to view timer settings, press the  and  buttons at the same time. The screen will display "Editor - Display" at the top once in Editor Mode.

Figure 26 - Editor - Display Screen









2. Press the right arrow next to the  button three times.  The top of the screen should now display "Editor - Timers". If this screen was passed accidentally, press the left arrow until back on the correct screen.



Figure 27 - Editor - Timers Screen

3. To toggle through the timers, press the down arrow below to the  button. To see a list of timers, please see "Timer Factory Default Settings" on page 41.
4. To make changes to the timer setting, press the  button and the setting that may be changed will start blinking.
5. Use the Up / Down arrows around the  button to change the setting.
6. Once changes are complete, press the  button again to finalize the changes and the settings will stop blinking.
7. To exit Editor Mode, press the  and  button at the same time for approximately 5 seconds. The screen will then display "Status" at the top of the screen, then return to source display screen.
8. Press the "Auto"  button to place the ATS back in "Auto" mode.

NOTE: Other timers are available for adjustment but may not be accessed from the front panel. Please refer to the full manual for additional timers and their description. Please contact Lake Shore Electric with any changes required to the LSE8600 program.

4.2.8. Timer Factory Default Settings

- a. S1 Transient Delay - (Not Used for Current ATS; Please Ignore for Most Applications)
 - ✓ Factory Default = 0 sec
- b. S2 Start Delay - Time Delay to Engine Start
 - ✓ Factory Default = 3 sec
- c. S2 Warming - Generator S2 Warm Up Time Before Loading
 - ✓ Factory Default = 5 mins

for Most

Applications

- d. S2 Fail to Start Delay - (Not Used for Current ATS; Please Ignore)
 - ✓ Factory Default = 60 sec
- e. Elevator Delay - Auxiliary Contact Before Transfer
 - ✓ Factory Default = 5 sec
- f. Non-Sync Transfer - Time Delay in Neutral (Both Source Switches Open and Load is in the Dark). NOTE: Other timers affect this setting, and the minimum time is 3 secs, but not seen on this timer.
 - ✓ Factory Default = 0 sec
- g. Check Sync Transfer - Used for Closed Transition Transfer Applications
 - ✓ Factory Default = 60 sec (60s on MP7650)
- h. S2 Return Delay - Time Delay to Return Load to Utility Power.
 - ✓ Factory Default = 15 mins
- i. S2 Cooling - This is the engine cooldown timer.
 - ✓ Factory Default = 10 mins
- j. S2 Fail to Stop Delay - When Displayed On Screen, Please Check The Connected Generator
 - ✓ Factory Default = Inactive or 60 sec
- k. S2 Transient Delay - (Not Used for Current ATS; Please Ignore for Most Applications)
 - ✓ Factory Default = 0 sec

4.2.9. ATS Exerciser Settings & Adjustments



1. To get to the editor screen to view timer settings, press the  and  buttons at the same time. The screen will display "Editor - Display" at the top once in Editor Mode.

Figure 28 - Editor - Display Screen



2. Press the right arrow next to the  button four times.  The top of the screen should now display "Editor - Schedule". If this screen was passed accidentally, press the left arrow until back on the correct screen.



Figure 29 - Editor - Schedule





3. To activate the "Plant Exerciser" feature of the LSE8600 controller, press the  button and the Inactive text will start blinking.
4. Press the Up arrow above to the  button, and the text will change to "Active".



Figure 30 - Editor - Schedule - Changed to Active

5. Press the  button to select.
6. Press the Down arrow under to the  button once.

7. The new screen will read Editor - Schedule - Bank 1 - Weekly.

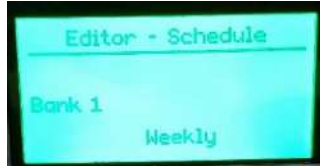

Figure 31 - Bank 1 - Weekly

8. To change from Weekly to Monthly, press the button and the Weekly text will start blinking. If Weekly generator exercising is required, skip to step 11.
9. Press the Up arrow above to the button, and the text will change to "Monthly". NOTE: if the text already says "Monthly" and "Weekly" is required, press the down arrow below to the button.
10. Press the button to select.
11. Press the Down arrow below to the button once.
12. The new screen will read Editor - Schedule - Bank 2 - Weekly.
13. If this schedule is being used, repeat steps 8 thru 10 to change Bank 2 settings.
14. Press the Down arrow below to the button once.
15. The screen will now show a screen like Figure 32 - Schedule Setup shown below.

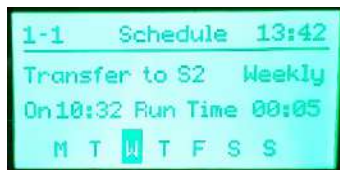







Figure 32 - Schedule Setup

16. To make a change to (1-1) Bank 1, set 1, press the button and the text in the same location as "Transfer to S2" will start blinking.
17. Use the Up / Down arrows around the button to change the setting.
18. Use the Right / Left arrows around the button to increment to the next selection (next selection will start blinking).
19. Once changes are complete, press the button again to finalize the changes to (1-1) Bank 1, set 1, and the settings will stop blinking.
20. There are 7 other sets to Bank 1 that may be set if applicable: (1-2), (1-3), (1-4), (1-5), (1-6), (1-7), (1-8).
21. There is a Bank 2 with 8 sets also if applicable: (2-1), (2-2), (2-3), (2-4), (2-5), (2-6), (2-7), (2-8).
22. If additional generator Exercising dates are required, repeat steps 11 thru 19 for additional exerciser banks/sets.

23. To exit Editor Mode, press the  and  button at the same time for approximately 4 seconds. The screen will then display "Status" at the top of the screen, then return to source display screen.
24. Press the "Auto"  button to place the ATS back in "Auto" mode.
25. The "Plant Exerciser" will now run the generator at the next scheduled time.
26. To see the settings programmed in, press the right arrow key next to the  button until the scheduler section is seen. This will scroll through all the settings at 5 second increments. To disable the scroll feature temporarily, press the Up-arrow key above to the  button and it will stay on the current screen. Manually scroll through the other screens using the Up / Down arrows after that.

4.2.10. Undervoltage Trip Settings for S1 and S2 Sources

Factory Default Settings (Default: Active Protection)

- S1 Pick-Up Setting: 90% of the nominal voltage.
- S1 Drop-Out Setting: 80% of the nominal voltage.
- S2 Pick-Up Setting: 90% of the nominal voltage.
- S2 Drop-Out Setting: 80% of the nominal voltage.

NOTE: If these values need to be adjusted, please contact the factory for assistance.

4.2.11. Overvoltage Trip Settings for S1 and S2 Sources

Factory Default Settings (If Applicable)

- S1 Pick-Up Setting: 115% of the nominal voltage.
- S1 Drop-Out Setting: 120% of the nominal voltage.
- S2 Pick-Up Setting: 115% of the nominal voltage.
- S2 Drop-Out Setting: 120% of the nominal voltage.

NOTE: If these values need to be adjusted, please contact the factory for assistance.

4.2.12. Under-Frequency Trip Settings for S1 and S2 Sources

Factory Default Settings (If Applicable)

- S1 Pick-Up Setting: 58 Hz
- S1 Drop-Out Setting: 30 Hz
- S2 Pick-Up Setting: 58 Hz
- S2 Drop-Out Setting: 30 Hz
- The Drop-Out Setting is set to half the frequency to prevent nuisance tripping during gen loading.

NOTE: If these values need to be adjusted, please contact the factory for assistance.

4.2.13. Over-Frequency Trip Settings for S1 and S2 Sources

Factory Default Settings (If Applicable)

- S1 Pick-Up Setting: 58 Hz
- S1 Drop-Out Setting: 62 Hz
- S2 Pick-Up Setting: 58 Hz
- S2 Drop-Out Setting: 62 Hz
- The Drop-Out Setting is set to half the frequency to prevent nuisance tripping during gen loading.

NOTE: If these values need to be adjusted, please contact the factory for assistance.

4.3. Installation

Installation of the LSE8600 Controller is straight forward and easy. Please follow the steps below and consult the drawings provided with the transfer switch. Reference section 3.2 Placing the Transfer Switch in Operation.

4.3.1. Generic Control Wiring Diagram

NOTE: See ATS drawing (XXXXXX-03) for final correct control wiring of specific unit.

Figure 33 - Example Wiring of the LSE8600 Controller is an example only.

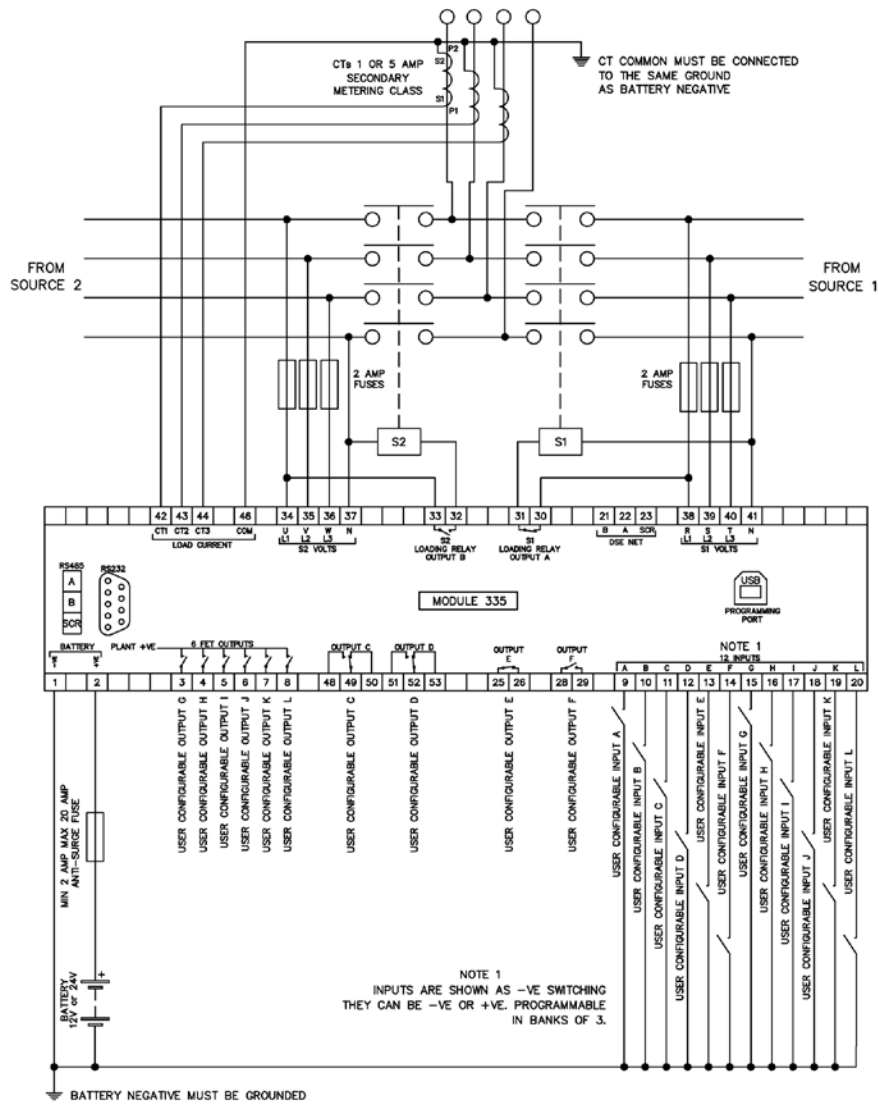

Figure 33 - Example Wiring of the LSE8600 Controller

4.3.2. Typical Wiring Diagrams - 3 ϕ 4W

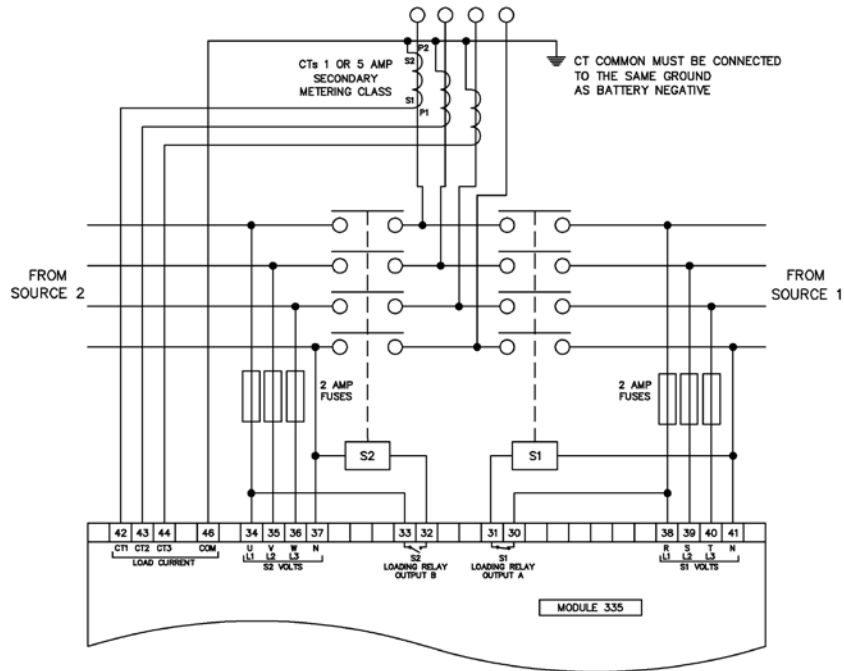

Figure 34 - Typical Wiring Diagram - 3 ϕ 4W

4.3.3. Typical Wiring Diagrams - 3 ϕ 3W

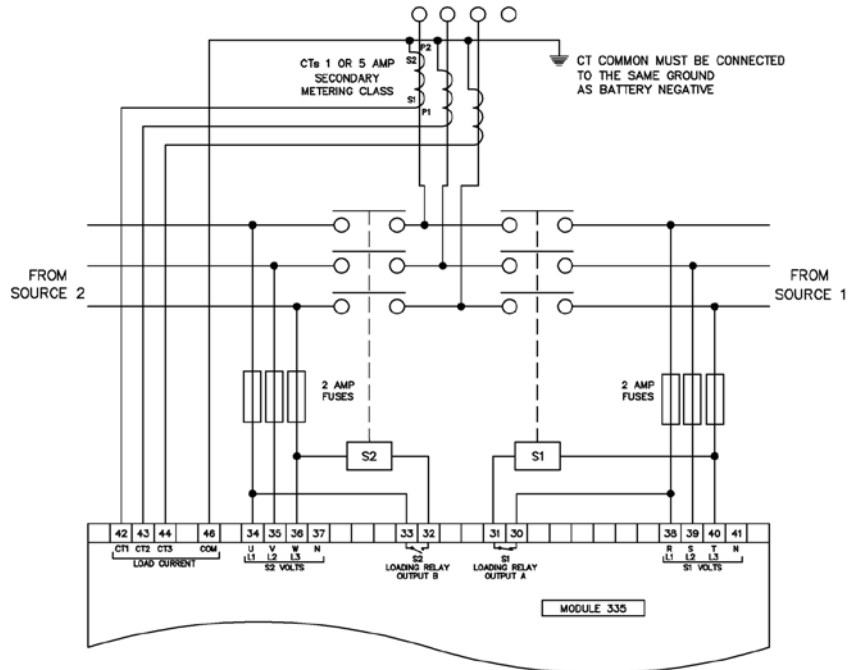

Figure 35 - Typical Wiring Diagram - 3 ϕ 3W

4.3.4. Typical Wiring Diagrams - 1 ϕ 2W

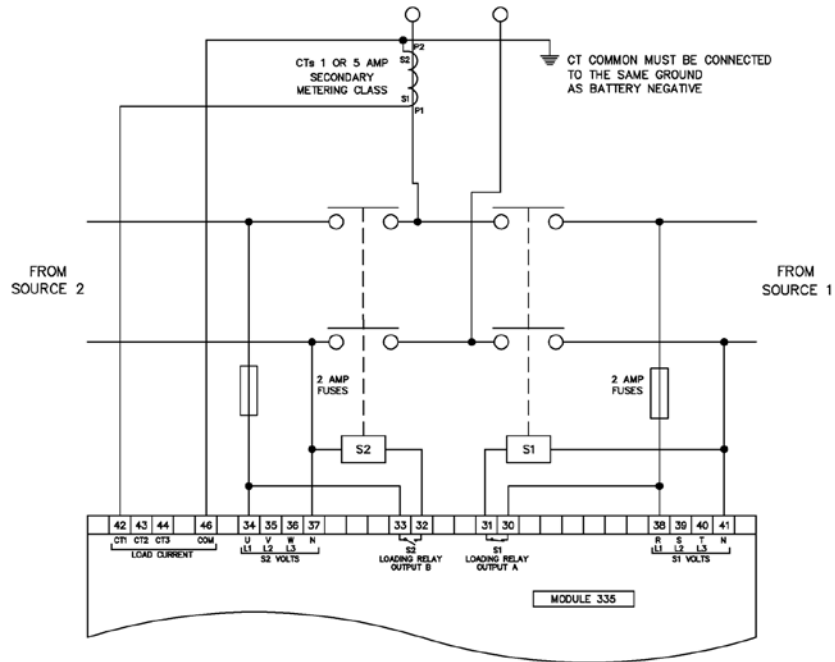

Figure 36 - Typical Wiring Diagram - 1 ϕ 2W

4.3.5. Typical Wiring Diagrams - 2 ϕ 3W (L1-L2)

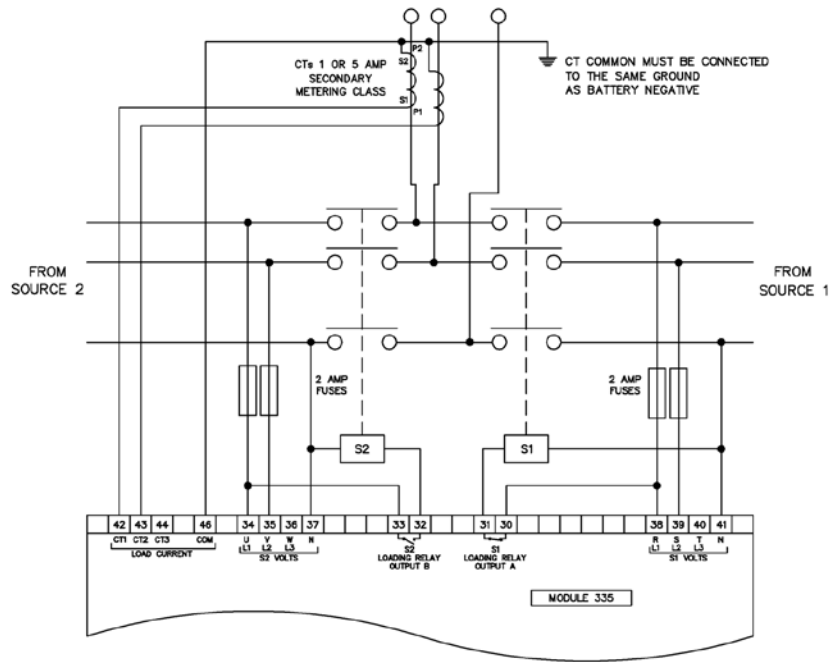

Figure 37 - Typical Wiring Diagram - 2 ϕ 3W (L1-L2)

4.3.6. Typical Wiring Diagrams - 2 ϕ 3W (L1-L3)

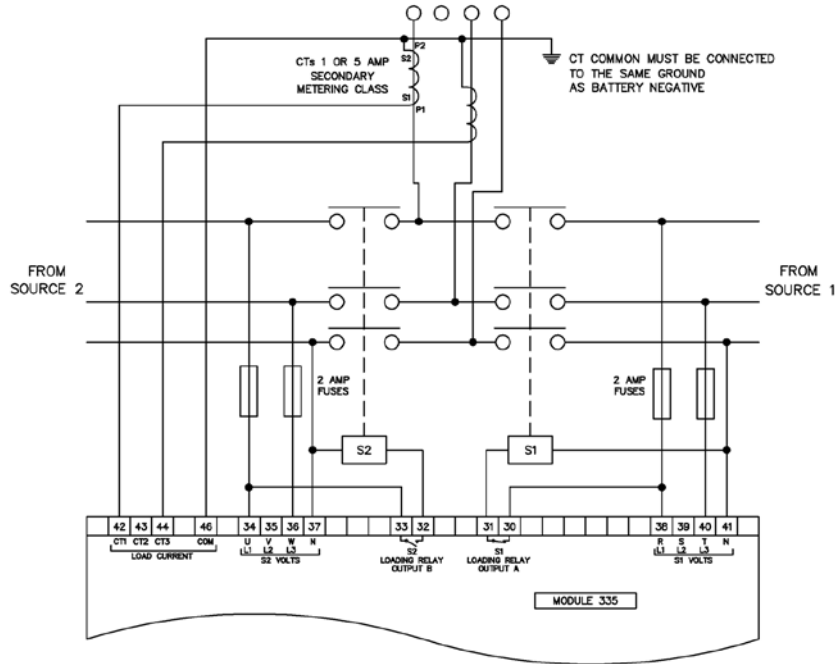

Figure 38 - Typical Wiring Diagram - 2 ϕ 3W (L1-L3)

5. Operating Mechanism

5.1. General Information

The operating mechanism pictured in Figure 39 - Gear Motor Assembly (page 51), is used in single motor operated, and dual motor operated transfer switches. The motor (4) is a universal type, reversible motor and is shipped as a complete component including the gearbox and motor control board. The gearbox is a sealed unit, which should never require maintenance or attention. Because of the wide range of molded case switches used on Lake Shore Electric Transfer Switches, if motor replacement is necessary, please specify the serial number and model number of the transfer switch.

5.2. Operation

When a signal to transfer is received from the LSE8600 Controller, the motor is energized, and the gear box turns the drive drum (8) which sets up a friction pull between itself and the drive shoe lining (13). This friction pull is enough to pull the drive arms (2) over to the new position, actuating the switch toggle. As soon as the drive arms have reached their new position, the auxiliary switch changes position signaling the controller to cut off the motor, while at the same time, setting up the circuit for the next transfer in the opposite direction. Because of the built-in features of the friction drive, it is possible to manually operate the switch by moving the manual handle (1) without engaging any clutches or devices.

5.3. Required Maintenance

Please refer to the Appendix A, Appendix B and Appendix C for required maintenance on the operating mechanism necessary to maintain your exclusive one-year Lake Shore Electric Corporation warranty.

5.4. Motor Assembly

To assemble the operating mechanism, first place the drive drum keys (11) on each side of the shaft, which extends from the gearbox. Next, slide the two drive drums (8) on the shafts. Insert one drive shoe pivot (10) into one drive arm (2) from the bottom, followed by the drive shoe (12) and the drive shoe lining (13). Be sure that the lining fits snugly into the drive shoe and that the concave cup end of the drive shoe pivot (10) engages the nipple on the drive shoe. Hold the entire assembly together and slip it onto one shaft, pushing it all the way to the drive drum. Now the spring (9) and adjustment screw (3) may be assembled into the drive arm (2) from the top. Repeat this procedure for the other drive arm assembly if present.

Place the lever arm support (17) in such a way that it straddles the gearbox and engages the drive arm assemblies on both sides of the gearbox. Tighten the mounting screws and assemble the lever arm across the two molded case switches by fastening the lever arm to the lever arm support with the manual handle assembly (1). Observe the molded case switch-actuating lever, as it manually opens and closes the molded case switch, checking that it completely transfers the molded case switches. (18) comes pre-attached to the motor housing. The disassembly procedure of the mechanism is the reverse of the above.

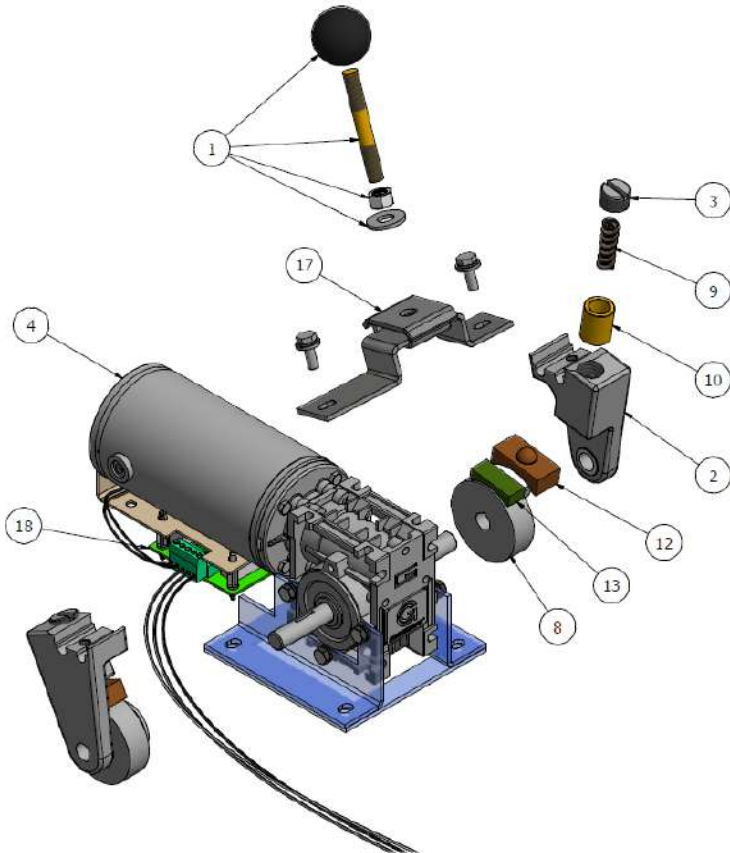

Figure 39 - Gear Motor Assembly

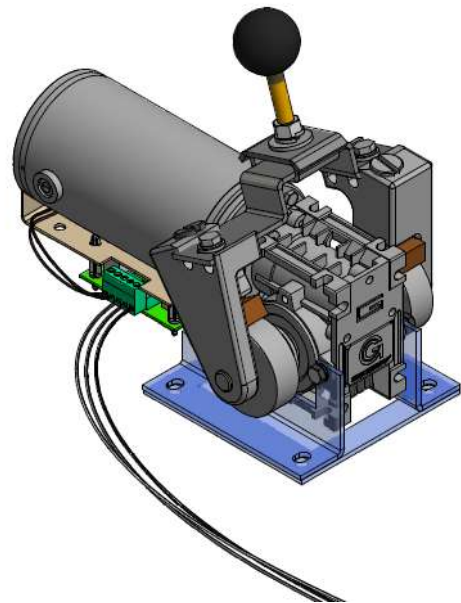

Figure 40 - Assembled Gear Motor

LEGEND

- | | |
|---------------------|--------------------------------|
| 1. Manual Handle | 10. Drive Shoe Pivot |
| 2. Drive Arms | 12. Drive Shoe |
| 3. Adjustment Screw | 13. Drive Shore Lining |
| 4. Motor | 17. Lever Arm Mounting Bracket |
| 8. Drive Drums | 18. Motor Control Board |
| 9. Spring | |

6. Molded Case Switches

6.1. General Information

The molded case switches used in transfer switches are the standard devices supplied by molded case switch manufactures. Figure 41 (page 52).

Thermal magnetic or magnetic trip units may be installed (Accessory CBTN and/or CBTE) for thermal overload and short circuit protection. When these trips are provided, a bell alarm contact is included inside the breaker to indicate to the transfer switch circuit that the breaker has tripped due to an overload. This signals the controller and prevents the transfer switch from connecting the other power source into a potential short circuit.

If either breaker trips due to overload, it can be reset by manually operating the transfer switch to a position so that the breaker resets. After resetting, return the transfer switch to the proper position. A shunt trip may also be provided. This allows the breaker to be electrically tripped from a remote location and can also be reset manually.

6.2. Inspection and Maintenance

Terminal lugs and trip units must be tight to prevent overheating. Due to the inherent wiping action built into the moving contacts of all molded case switches, operating the switch several times under load will remove any high resistance film that may have formed. Under normal conditions, additional cleaning of contacts is not required. However, should operating and/or atmospheric conditions make it desirable to clean the contacts further, the following procedure is recommended. (Refer to Figure 41).

Remove cover, arc chutes, and cable terminal assemblies. Wipe contact surfaces with a clean, lint free cloth. If surfaces are excessively oxidized or corroded, scrape lightly with a fine file before wiping.

The auxiliary micro switches are mounted internally to the molded case switch.



Figure 41 - Molded Case Unit - Internal View

7. Troubleshooting Guide

This guide is intended to assist an individual with a basic understanding of electrical circuitry to troubleshoot an automatic transfer switch as manufactured by Lake Shore Electric Corporation. Any questions relating to the use of this Manual should be referred to the Service Department of Lake Shore Electric Corporation, 205 Willis Street, Bedford, Ohio 44146, Phone (440) 232-0200, Fax (440) 232-5644.

CAUTION: WHEN WORKING ON EQUIPMENT OF THIS TYPE, EXTREME DANGER FROM ELECTRICAL HAZARDS EXISTS. DO NOT ATTEMPT ANY REPAIRS OR ADJUSTMENTS TO THIS EQUIPMENT WITHOUT TAKING EVERY PRECAUTION TO PREVENT AN ACCIDENT.

WARNING!

IN INSTALLATION AND USE OF THIS PRODUCT, COMPLY WITH THE NATIONAL ELECTRICAL CODE, FEDERAL, STATE AND LOCAL CODES, AND ALL APPLICABLE SAFETY CODES. IN ADDITION, **TURN OFF POWER** AND TAKE OTHER NECESSARY PRECAUTIONS TO PREVENT PERSONAL INJURY AND EQUIPMENT DAMAGE.

WHEN WORKING ON EQUIPMENT OF THIS TYPE, EXTREME DANGER OF ELECTROCUTION EXISTS. THIS MAY RESULT IN INJURY OR DEATH. **DO NOT ATTEMPT ANY REPAIRS OR ADJUSTMENTS TO THIS EQUIPMENT WITHOUT FIRST TAKING EVERY PRECAUTION TO PREVENT ACCIDENTAL INJURIES.**

The following conditions **MUST** be met before attempting to troubleshoot a molded case transfer switch:

1. A wiring diagram for the switch must be available.
2. Normal and Emergency voltage and frequency must be available and within the correct operating limits.
3. Control circuit voltage (if transformers are used) must be 110 to 125 volts on their secondary side.
4. Verify the readings on the LSE8600 are correct for system voltage. If they are not as expected, measure the voltage directly at the incoming terminals to the ATS. Use all appropriate caution necessary when performing those measurements.
 - a. Check wiring to the LSE8600 controller if direct measurements are correct. Possible bad controller if wiring checks out "OK".
5. All timers must be turned down or considerations given to them while the tests are being conducted. (i.e.: Return Delay)
6. If trip units are included in the switch, they must be reset if previously tripped due to an overload.
7. All electrical connections must be tight and in accordance with the wiring diagram.
8. All components must be free of obvious defects apart from normal usage.
9. The switch must be connected to a good earth ground.

When you are satisfied that all the above conditions are met, and all accessories are either working correctly or eliminated, the problem will be confined to:

1. LSE8600 Controller
2. Adjustment of the Operating Mechanism (See Appendix A on page 78 for Instructions)
3. Expansion Boards
 - a. DSE2130
 - b. DSE2157
 - c. DSE2548
4. Other Issues (Please Contact Lake Shore Technical Support)
 - a. Interconnections & Cable Connections
 - b. Molded Case Breaker / Switch
 - c. Internal Auxiliary / Bell Alarm / Shunt Trips inside Molded Case Breaker / Switch
 - d. Motor Operation Faulty

The troubleshooting procedures outlined here are designed to test the control circuit and the operating mechanism of the transfer switch. It is, therefore, necessary that all factors external to the transfer switch are correct, and that all accessory devices which are not imperative to switch operation either operate satisfactorily or are disconnected from the circuit.

Many of the accessory devices described below may not exist in the transfer switch being examined. The proper wiring diagrams should be on hand before beginning work on the switch. We recommend that the entire manual be read before attempting to make any adjustment. Above all, **CAUTION** is recommended.

7.1. LSE8600 Configuration Suite Software Installation Instructions

Before troubleshooting begins, please download the current version of the Partner Software, DSE Configuration Suite Software Installer. A copy of this software may be downloaded from the following link: <https://www.deepseaelectronics.com/ats/automatic-transfer-switch-control-modules/dse335/software>. This site requires you to create an account before you may download and install this software. Be sure to save the log in information created, for it is required during software installation.

Once the download is complete, double click Web Setup from your downloads folder.



1. Click **Next** to continue.

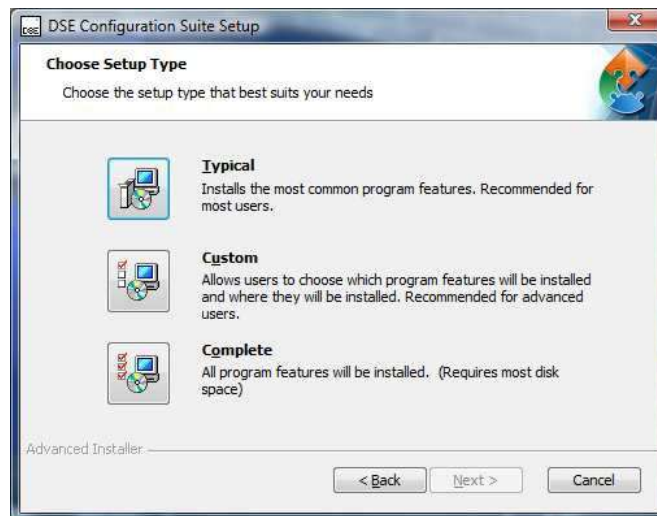

2. Select *Typical* (only installs the common program features), *Custom* (allows the user to customize to installation) or *Complete* (installs all software packages) to start the installation.

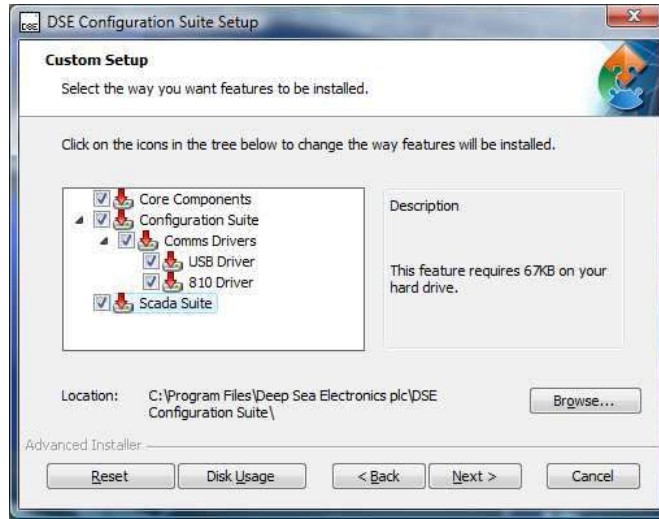

3. Example Showing the Custom installation window. Click **Next** to continue.

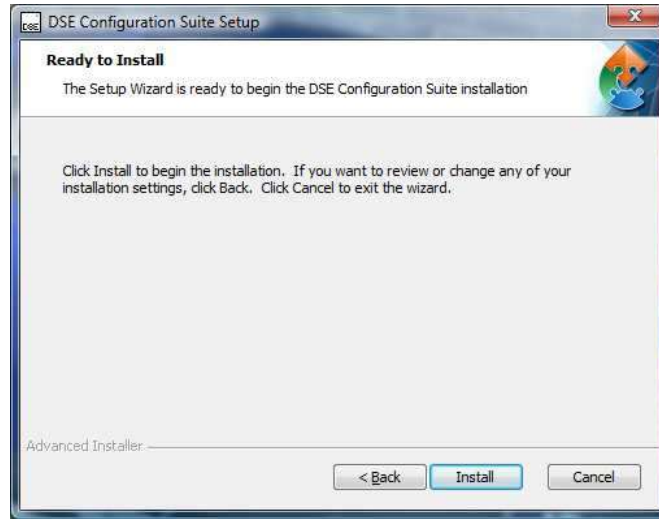

4. Click **Install** to continue.

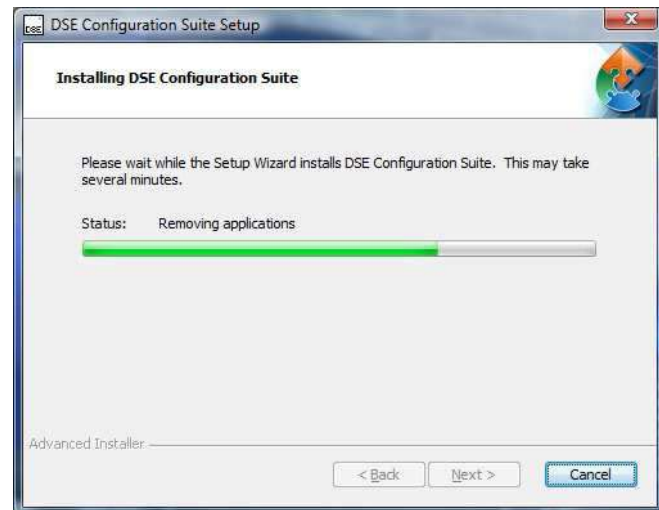



5. Enter your login details for the DSE Website. Click **Ok** to continue.

NOTE: - To register on our website please visit: <http://www.deepseapl.com/members/register/>

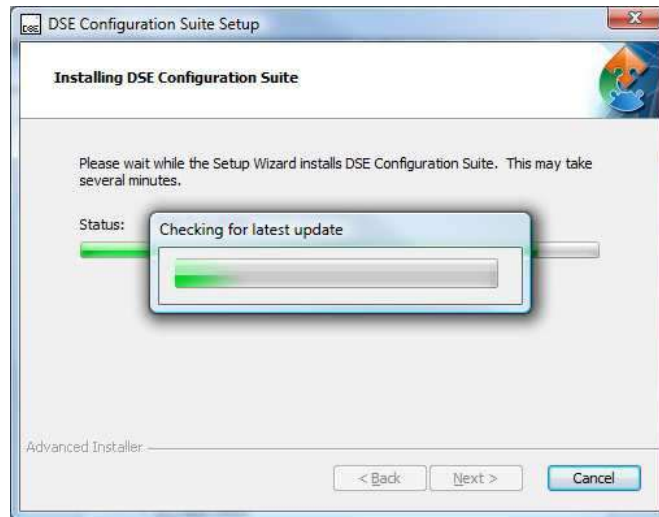

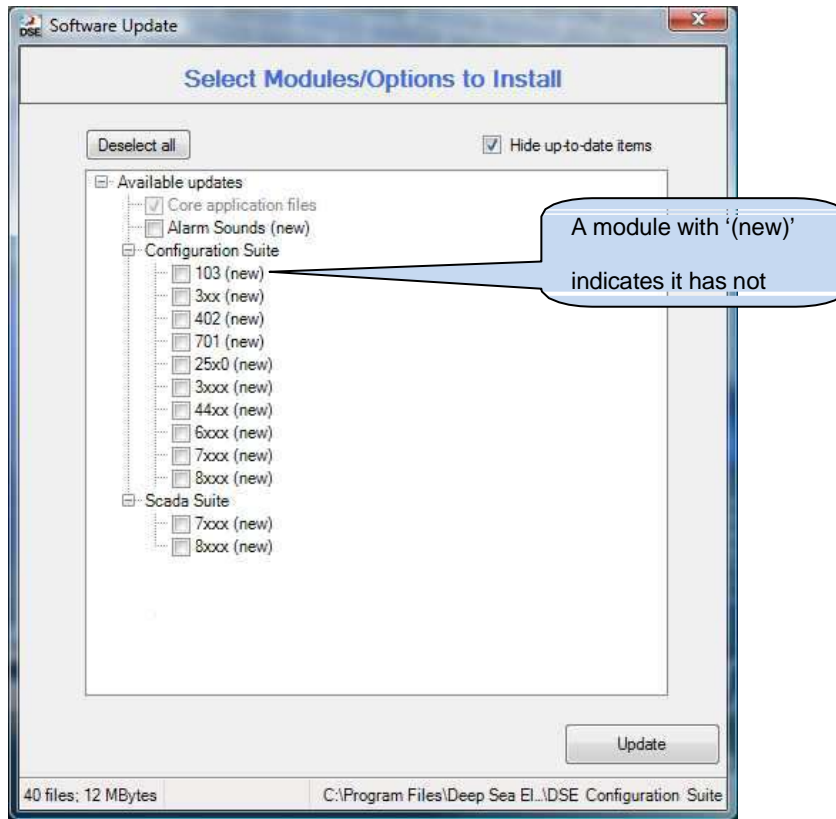

6. Select the modules which are to be installed with the software. Click **Update** to continue.

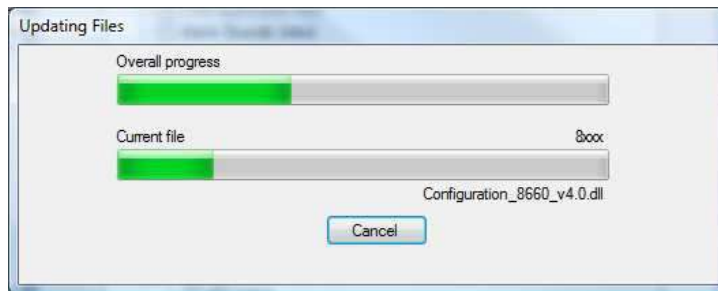

7. The installer will then either download or install the modules selected.

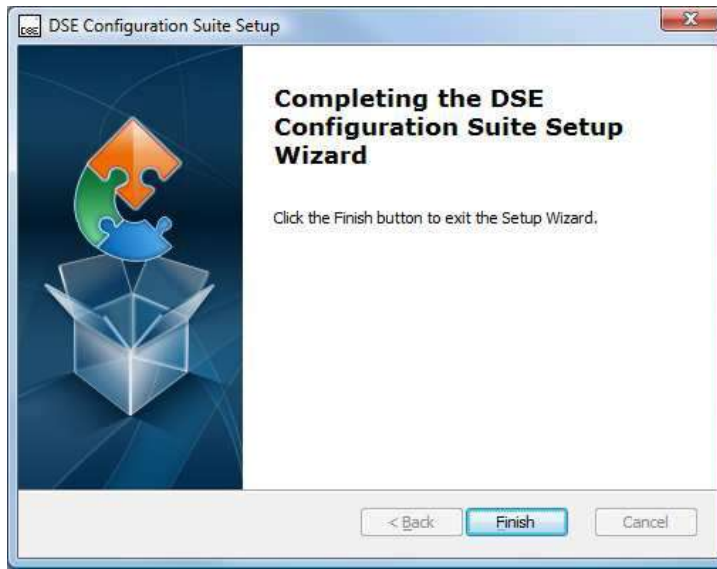

8. Click **Finish** to complete the installation.

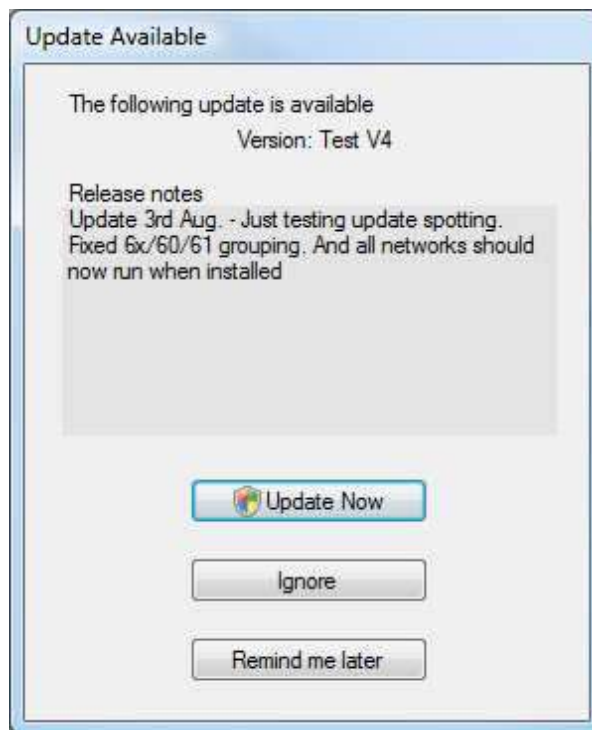

9. If there is an internet connection and updates are available, this window will be displayed when the software starts. Click **Update Now** to begin the procedure.

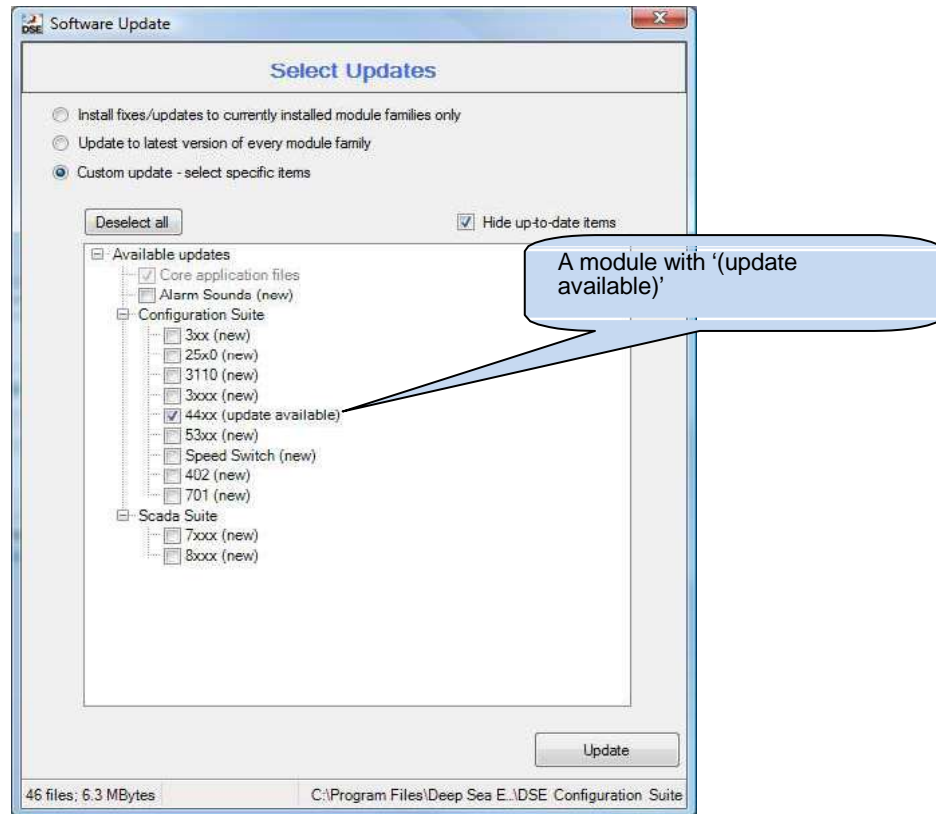

10. Select the type of software update (**3xx (new)**) required. Click **Update** to continue.

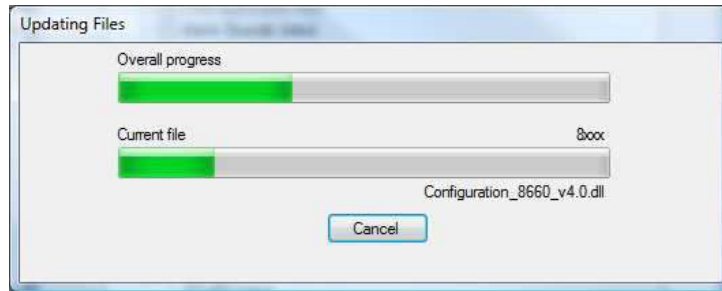

11. The software will then download the selected updates.

12. Once the software has been successfully installed and updated, click on the DSE Configuration Suite icon button located in your Start Menu.

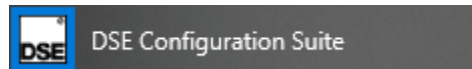

Figure 42 - DSE Configuration Suite Icon

13. The following main screen will be displayed.

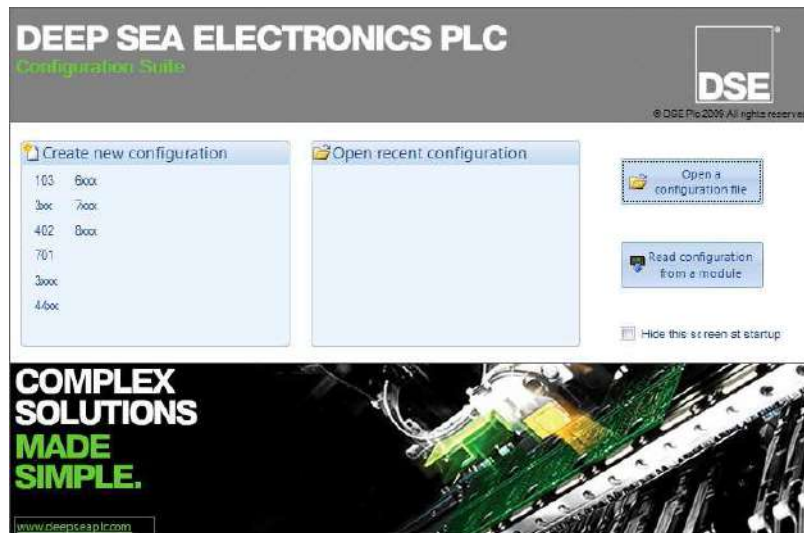

Figure 43 - Main Configuration Suite Software Screen

14. Please make sure your standard A to B USB cable has been connected to your PC and to the back of the controller installed in the ATS.
15. Once that has been connected, click on the “Read configuration from module” button located on the right-hand side of the screen.
16. This will read the current configuration code for your ATS LSE8600 controller.
17. From here, please click on the down arrows  located in the lower left-hand side of the screen. The box is labeled “Scada”. This will load the Real Time Scada information from the controller.



Figure 44 - LSE8600 Controller - Open Scada Information

18. Scroll down and click on the “Event Log” option. This will load the current event log saved on the LSE8600 controller. See Figure 45 - Event Log Screen below.

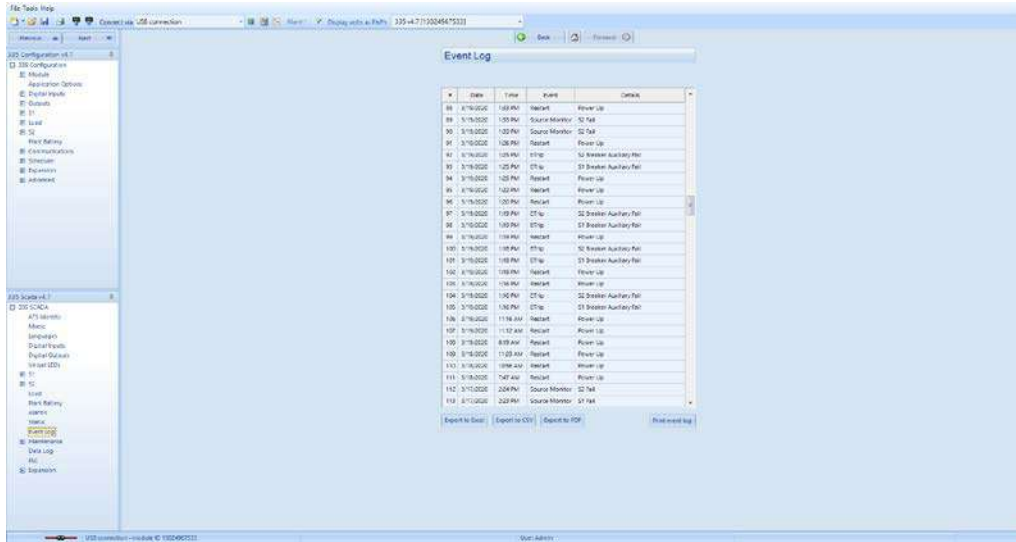

Figure 45 - Event Log Screen

19. Export this information by scrolling to the bottom of the screen and clicking on “Export to PDF”.
20. Save the file and email it to support@lake-shore-electric.com for analysis along with the appropriate contact info. Someone will contact you back within 24 business hours.

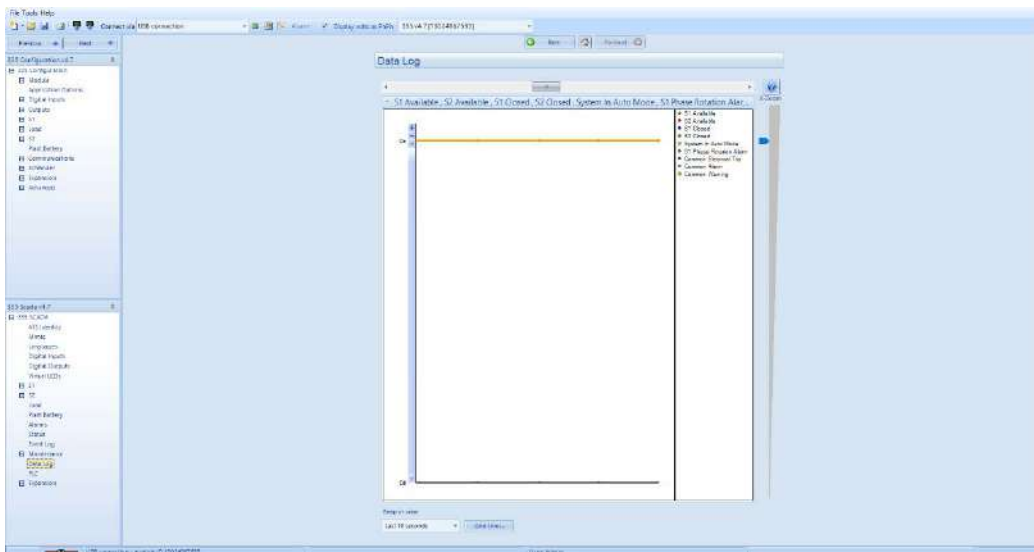

Figure 46 - Data Logging Screen

21. The Data Logging Information may also be accessed from the same location. Click on “Data Log” to view your current live LSE8600 controller information.

7.2. LSE8600 Controller Issues

After confirming any/all external faults that may have occurred to the ATS have been cleared, please power cycle the LSE8600 controller using the “CES” keyed switch located on the door next to the controller. This will clear any program faults that it may have encountered during this time. If the controller is still having issues, please proceed.

NOTE: The below fault-finding tables are provided as a guide checklist only. As the module can be configured to provide a wide range of different features, always contact Lake Shore Electric if the LSE8600 Controller configuration is in doubt.

Table 17 - Starting

Symptom	Possible Remedy
Unit is inoperative Read/Write configuration does not operate	Check the battery and wiring to the unit. Check the DC supply. Check the DC fuse.
Unit shuts down	Check DC supply voltage is not above 35 Volts or below 9 Volts Check the operating temperature is not above 70 °C. Check the DC fuse.
Fail to Start is activated	Check wiring of the S2 sensing cables. Check the start output is correctly wired into the generator controller.
Continuous starting of S2 when in <i>Auto</i>  mode.	Check that there is no signal present on the “Remote Start” input. Check configured polarity is correct. Check the S2 supply available and within configured limits
S2 fails to start or go on load on receipt of Remote Start signal.	Check S2 Fail Delay timer has timed out. Check signal is on “Remote Start” input. Confirm correct configuration of input is configured to be used as “Remote Start”.

Table 18 - Loading

Symptom	Possible Remedy
S2 supply present runs but does not take load	Ensure S2 is available and within configured limits and a load inhibit signal is not present on the module inputs. Check connections to the switching device. Note that S2 does not take load in manual mode unless there is an active remote start on load signal.

Table 19 - Alarms

Symptom	Possible Remedy
Electrical Trip fault operates	Check relevant switch and wiring of fault indicated on LCD display. Check configuration of input.
Warning fault operates	Check relevant switch and wiring of fault indicated on LCD display. Check configuration of input.

Table 20 - Instruments

Symptom	Possible Remedy
Inaccurate S1 & S2 measurements on controller display	<p>Check that the CT primary, CT secondary and VT ratio settings are correct for the application.</p> <p>Check that the CTs are wired correctly with regards to the direction of current flow (P1, P2 and S1, S2) and additionally ensure that CTs are connected to the correct phase (errors occur if CT1 is connected to phase 2).</p> <p>Remember to consider the power factor. i.e. (kW = kV A x power factor)</p> <p>The controller is true RMS measuring so gives more accurate display when compared with an 'averaging' meter such as an analogue panel meter or some lower specified digital multimeters.</p> <p>Accuracy of the controller is better than 1% of full scale. i.e. S1 volts full scale is 333 V, phase-neutral, so accuracy is ± 3.33 V (1% of 333 V).</p>

7.3. Relay Expansion Board(s) (If Applicable)

This section will provide a brief troubleshooting guide to the possible problems with the expansion board(s) that may be installed in the ATS. Please call the technical support line for help for more information if needed.

7.3.1. DSE2130 - Input Expansion Board

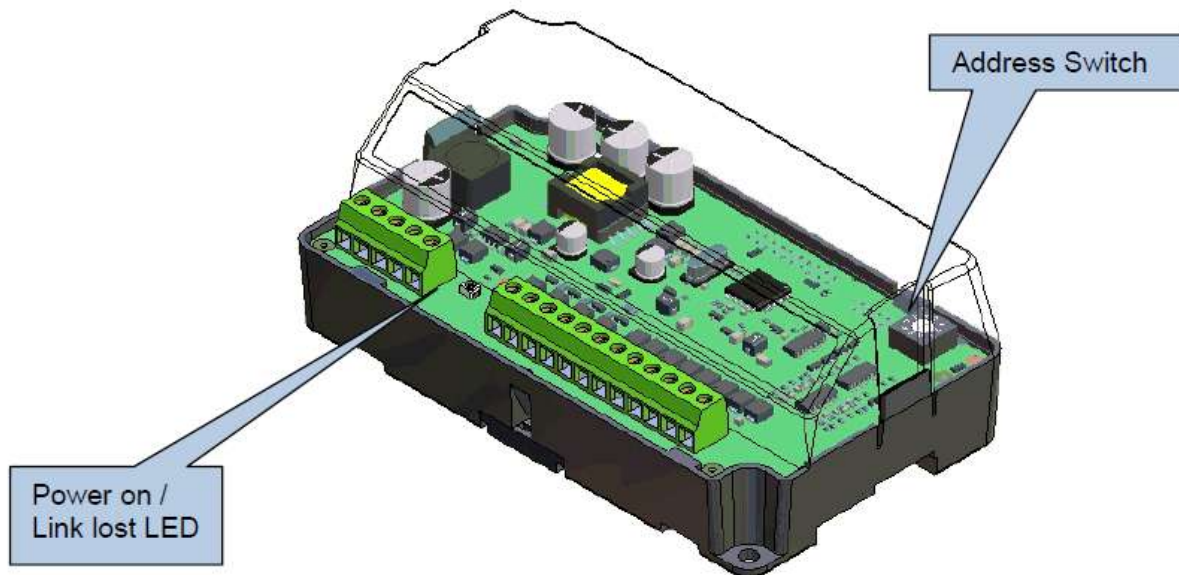

Figure 47 - DSE2130 Controls and Indications

Table 21 - DSE2130 LED Indications

Function	Color	Action
Power on / Link Lost	RED	Steady when DC supply is connected, and data is being received from the host controller. Flashing when the DC supply is connected and the data connection to the host controller is not operating.

ID Switch - The rotary ID switch is used to select the 'Identification' of the 2130 expansion module as the host controller gives instructions to a number of 2130 expansion modules at the same time.

Consult the relevant module's operating instructions for further details on number of supported expansion units.

The enclosure cover must be unclipped, and removed, to gain access to the switch. The switch should be operated using a small screwdriver and set to match the required ID.

NOTE: The ID must be set to be a unique number, different from the ID of any other 2130 input expansion module connected on the DSEnet. The ID of the 2130 will not interfere with the ID of any other *type* of expansion module. For instance, it is OK to have a 2130 with ID1 and a 2157 with ID1, as the two modules are a different type of expansion board.

Table 22 - DSE2130 Fault Diagnosis

Fault Indications	Suggestion
Inputs don't Activate on the Host Controller	Ensure the host controller is correctly configured to accept the DSE2130
Power LED Indication Does Not Illuminate	Check polarity and size of the connected DC supply are within the specifications of the DSE2130
Power LED Flashes	This means the communications link to the host controller has been lost. Check the connection of the DSEnet paying particular attention to the cable type being used and the positioning of the termination resistors.

Please contact Lake Shore Electric Technical Support if unable to resolve the expansion boards problem.

7.3.2. DSE2157 - Output Expansion Board

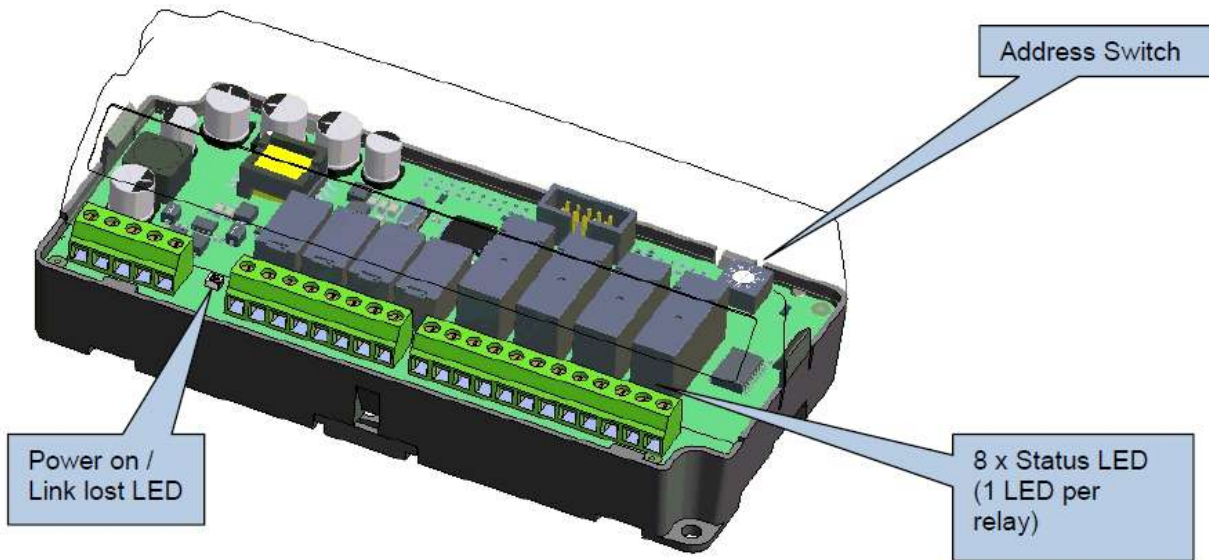

Figure 48 - DSE2157 Controls and Indications

Table 23 - DSE2157 LED Indications

Function	Color	Action
Power on / Link Lost	RED	Steady when DC supply is connected, and data is being received from the host controller. Flashing When the DC supply is connected and the data connection to the host controller is not operating.
Status 1-8	RED	Lit when the corresponding relay is active.

ID Switch - The rotary ID switch is used to select the 'ID' of the 2157 expansion module. The host controller gives instructions to one, or a number, of 2157 expansion modules at the same time.

The enclosure cover must be unclipped, and removed, to gain access to the switch. The switch should be operated using a small screwdriver and set to match the required ID.

NOTE: The ID must be a unique number, different from the ID of any other 2157 module connected to the host controller. If two or more 2157 controllers are required to 'mimic' each other then they should be configured with different IDs, and both configured the same in the host controller.

Table 24 - DSE2157 Fault Diagnosis

Fault Indications	Suggestion
Relays don't Activate on the 2157 Board	Ensure the host controller is correctly configured to send signals to the DSE2157
Power LED Indication Does Not Illuminate	Check polarity and size of the connected DC supply are within the specifications of the DSE2157
Power LED Flashes	This means the communications link to the host controller has been lost. Check the connection of the DSEnet paying particular attention to the cable type being used and the positioning of the termination resistors.

Please contact Lake Shore Electric Technical Support if unable to resolve the expansion boards problem.

7.3.3. DSE2548 - LED Annunciator Expansion Board

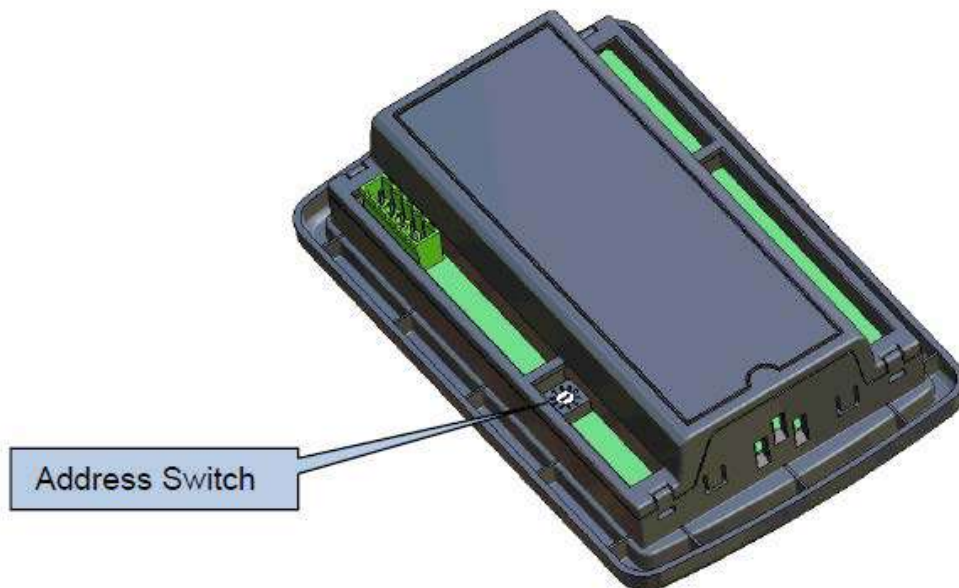

Figure 49 - DSE2548 Controls and Indications

Table 25 - DSE2548 LED Indications

Function	Color	Action
Power on / Link Lost	RED	Steady when DC supply is connected, and data is being received from the host controller. Flashing When the DC supply is connected and the data connection to the host controller is not operating.
Status 1-8	RED	Lit when the corresponding channel is active.

ID Switch - The rotary ID switch is used to select the 'Identification' of the 2548 expansion module as the host controller is capable of giving instructions to a number of 2548 expansion modules at the same time (consult relevant modules instructions for further details on number of supported expansion units).

The switch (located at the rear of the module) should be operated using a small screwdriver and set to match the required ID.

NOTE 1: The ID MUST be a unique number, different from the ID of any other 2548 module connected to the host controller.

If two or more 2548 controllers are required to 'mimic' each other then they should be configured with different IDs, and both configured the same in the host controller.

NOTE 2: The selection of the ID of *other types* of expansion modules WILL NOT interfere/clash with the ID of the 2548. For instance, if the 2548 is set to ID4, it is acceptable to have a *different type* of expansion module (for instance 2130) set to ID4 also.

Sounder - The 2548 LED expansion module has an integral sounder, activated upon a signal from the 'host controller'. The controller will activate the sounder when an alarm becomes active and silence the sounder when an alarm mute button (local or remote) is pressed.

Push Button - Pressing the button will signal to the host controller that the button is pressed. The controller will respond by lighting all LEDs on the 2548 module (lamp test) and silencing the sounder (alarm mute). If configured to do so, the host controller will also perform a lamp test and alarm mute function.

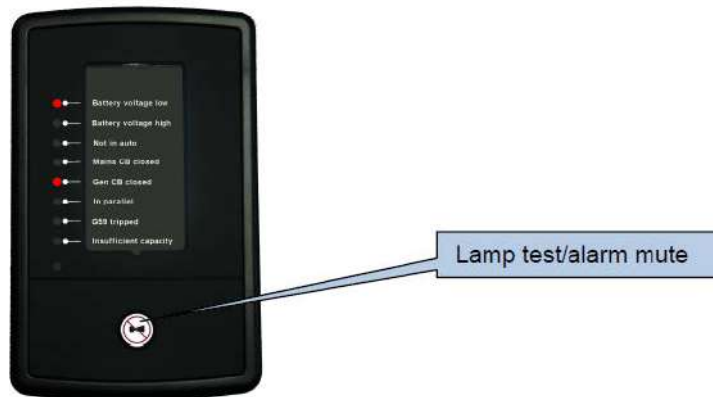

Figure 50 - DSE2548 Remote Horn Silence Push Button

Table 26 - DSE2548 Fault Diagnosis

Fault Indications	Suggestion
Relays don't Activate on the 2548 Board	Ensure the host controller is correctly configured to send signals to the DSE2548
Power LED Indication Does Not Illuminate	Check polarity and size of the connected DC supply are within the specifications of the DSE2548
Power LED Flashes	<p>This means the communications link to the host controller has been lost.</p> <p>Check the connection of the DSEnet paying particular attention to the cable type being used and the positioning of the termination resistors.</p>

Please contact Lake Shore Electric Technical Support if unable to resolve the expansion boards problem.

7.4. Other Issues

There are other possible issues that will cause the ATS to go into a fault state such as the following:

- a. Interconnections & Cable Connections
- b. Molded Case Breaker / Switch
- c. Internal Auxiliary / Bell Alarm / Shunt Trips inside Molded Case Breaker / Switch
- d. Motor Operation Faulty

If any of these are the suspected cause of the ATS fault state, please contact Lake Shore Electric Technical Support for assistance.

8. Standard and Optional Accessories

Lake Shore Electric offers many additional accessories for the Single Motor Operator and Dual Motor Operator transfer switches. Please check the documents and drawings for a specific switch to see what additional options are included.

8.1. Service Entrance (Optional)

This option provides for the Automatic Transfer Switch to be labeled as suitable for use as service equipment. The Actual determination of designating it as service equipment rests with the engineer in charge of the project or the authority having jurisdiction. When the Service Entrance accessory is selected, the Transfer Switch is suitable for use as Service Entrance Equipment and is provided with the following additional equipment:

1. Padlockable Enclosure
2. Over Current Trip and Bell Alarm for the Service Disconnect
3. LED Indication of Source “Tripped”
4. A Means to Disable the HMI Keypad
5. Neutral Bus with Main and Ground Lugs
6. Main Bonding Jumper per NEC 2002 250.8
7. Appropriate Nameplates and Instructions to be Applied in the Field

Instructions and labeling that accompanies the service entrance transfer switch will be in the following format.

1. When required by the National Electric Code or the engineer in charge of the project, connect one side of the grounding strap that is presently mounted on the neutral bar to ground. The other side of the grounding strap will remain connected to the neutral bar.
2. Apply the “SERVICE DISCONNECT” label on or near the operating handle of the Normal circuit breakers as required per the National Electrical Code or the engineer in charge of the project.
3. Apply the “SERVICE ENTRANCE” label on the outside of the enclosure door above the door handle.

If the building is supplied by more than one service, a permanent plaque or directory should be installed at this service disconnect denoting the location of all other services, feeders and branch circuits supplying this building in accordance with 2002 NEC 230-2.E.

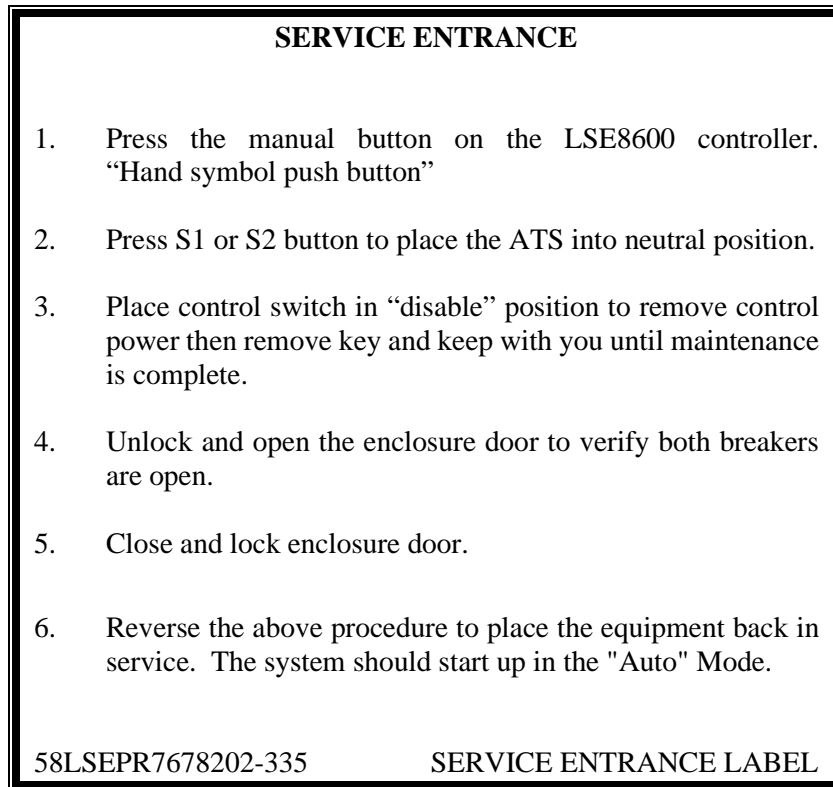

Figure 51 - Service Entrance Label

8.2. Ground Fault Protection or Indication - GFP / GFPE / GFPL / GFI (Optional)

This option provides ground fault detection in one of three places: 1) normal power, 2) emergency power, or 3) the load bus of the transfer switch. Once the ground fault is detected, the switch can be factory configured to provide either **protection** or **indication**.

Ground fault protection means that the display will show (flashing) "Ground Fault Detected" on the Alarms screen. The breaker will trip open the connected source and the load will be disconnected. The switch will be automatically placed in and "Alarm" state and the HMI LCD will display:

Table 27 - Ground Fault Detected - Protection

Alarms
Ground Fault Detected
Electrical Trip

Ground fault indication means that the display will show (non-flashing) “Ground Fault Detected” on the Alarms screen; however, the operation of the transfer switch will not be interrupted, and the mode of operation will not be changed.

Table 28 - Ground Fault Detected - Indication

Alarms	
Ground Fault Detected	
Warning	

8.3. Auxiliary Contacts Before Transfer - ACBT (Standard)

This option provides an additional timer, TDBT (Time Delay Before Transfer). This timer is adjustable from 0 to 300 seconds, (5 mins), and is factory set at 10 seconds. It is initiated when the switch is ready to transfer, both sources are available, and upon its completion, the transfer will take place. After the transfer is complete, the ACBT output contact will remain in its present state for another count of the time delay before the contact switches states. This is typically used in elevator circuits but can be used in other applications where motor disconnection before transfer is desirable. This timer is not initiated wherever there is a failure of either power source since its implementation would only serve to delay a transfer to the available source.

A 2-pole relay, labeled "EC", is driven by a configurable FET Output (i.e.: "G" thru "L") from the LSE8600 controller. Refer to the Unit specific drawings (XXXXXX-03) and connect to the relay outputs shown on the drawing for the required "elevator controls".

While this timer is counting down, its status will be displayed on the HMI LCD display.

Table 29 - ACBT when Transferring to S2

S2 Available		
Elevator Control		00:04↓
L-N	### V	#### A
L-L	### V	##.# Hz

Table 30 - ACBT when Transferring to S1

Wait for S2 Off Load		
Elevator Control		00:04↓
L-N	### V	#### A
L-L	### V	##.# Hz

8.4. Surge Suppression TVSS - SPD (Optional)

This option provides hard-wired secondary surge arrestors on both the normal and emergency sources if requested to protect both the ATS controls and the load connections. Or if protection is only requested for the load, only a single SPD will be connected to the ATS output connections to protect the customers load only.

This provides a degree of protection for voltage surges and lightning strikes. They are suitable for use in service entrance locations and meet the requirements of NEC 280, UL 1449 and ANSI C62.11. They protect surges up to 40 kA per Phase. No field installation is necessary.

If higher surges are expected, units that offer a higher surge protection may be installed. Please contact the factory for custom size requests.

NOTE: Please note, depending on the size of the surge arrestor, the SPD(s) may have to be mount externally to the ATS and will increase the overall footprint of the ATS enclosure. Engineering submittal drawings may be requested for analysis by the customer to determine if the increased size of the footprint will pose any issues.

8.5. Remote Disconnect - RD (Optional)

This option provides an input to the LSE8600 controller that will remove the Load from both sources. While that input is held active, the Load will remain in the dark. Customer interconnections can be made at the terminal block. Please see unit specific drawings for connection detail.

8.6. Circuit Breaker Trips - CBTN / CBTE (Optional)



This option provides circuit breaker trip units on either or both sides of the transfer switch. Trip units will come complete with one form "C" bell alarm. When tripped, the transfer switch sent to the "Alarm - Electrical Trip" Fault mode, and the appropriate light will be illuminated on the LSE8600 HMI.

8.7. Source Available Auxiliary Contacts - ACSA (Standard)

This option provides one or two form "C" contacts for customer use. They are identified as "EMR" (Emergency Available Relay) and "NOR" (Normal Available Relay). Please see unit specific drawings for quantity and connection detail.

8.8. Mode - Test On Load (Standard)

This option is the standard feature programmed into the LSE8600. The steps to perform a Load Test from the front HMI Screen are the following:

1. Press the Mode  button until the top line reads “Test On Load”.
2. Press the  button to confirm selection.
3. The ATS will now transfer to source S2.
4. To Return to Auto Mode, press the Auto  button and the ATS will resume normal operation.
5. If the LSE8600 does not transfer back to source S1, restart the LSE8600 by power cycling it. Leave the controller off for a count of “3” before applying power.

8.9. Mode - Test Off Load (Standard)

This option is the standard feature programmed into the LSE8600. The steps to perform a test of the source S2, (Generator), without connecting the Load to source S2. To start the source S2 from the front HMI Screen, perform the following steps:



1. Press the Mode  button until the top line reads “Test Off Load”.
2. Press the  button to confirm selection.
3. The ATS Screen will look like Table 31 - Test Off Load below.

Table 31 - Test Off Load

Test Off Load	XX:XX Time
S1 Available	
S2 Available	
S1 Closed	

4. To Return to Auto Mode, press the Auto  button and the ATS will resume normal operation.
5. If the LSE8600 does not transfer back to source S1, restart the LSE8600 by power cycling it. Leave the controller off for a count of “3” before applying power.

8.10. Load Demand Inhibit - LDI (Standard)

This option provides an input to the transfer switch, which forces transfer from emergency to normal (or neutral if normal is not available) and prohibits the transfer to emergency when normal is not available. This option is used in conjunction with load demand control in associated Lake Shore Electric Paralleling Switchgear. The input is a two-wire connection as shown on the drawings.

8.11. Peak Shave - PS (Standard)

This option provides an input to the transfer switch, which will initiate a transfer of the load to source S2. Should source S2 fail, or fail to start, the switch will return to source S1. This is typically used in conjunction with peak shaving Lake Shore Electric Paralleling Switchgear. The input is a two-wire connection. See unit specific drawings for connection detail.

8.12. Manual Return to Normal - MRTN - (Standard)

This option eliminates the “S2 Return Delay” timer. By pressing the S1 push button on the LSE8600 HMI display, it will bypass this timer and bring the return to source S1 immediately.



8.13. Closed Transition Transfer - CTT (Optional)

This option provides for a closed transition (make before break) transfer from normal to emergency when both sources are available and a closed transition transfer from emergency to normal to complete the transfer cycle.

Included with this option is a timer “Check Sync” timer. This timer when timing will be displayed on the HMI LCD as shown here.

Table 32 - Check Sync Transfer Timer

Engine Start	XX:XX Time
Check Sync	XX:XX Time

The closed transition with *Check Sync* functionality allows for both load switching devices to be closed, and thus both supplies in parallel, for the preconfigured *Parallel Time*. As soon as the LSE8600 detects the load switching device of the supply the load is being transferred to has closed, the *Parallel Time* timer begins. Once this timer has expired, the LSE8600 opens the load switching device of the supply the load has been transferred from. If at any time during this process a load switching device is detected to have not opened or closed as instructed, one or multiple alarms are generated. At this point the LSE8600 configures the load switching devices to ensure continued supply of the site load where possible. Following such instances, load switch alarms may be cleared without putting the LSE8600 into *Stop* mode by pressing and holding the *Mute*  button on the front of the module for 5 seconds. Doing so only resets these alarms, leaving any other latched or active alarms still present. Pressing the *Stop*  button when in *Stop* mode also clears the load switch alarms, along with any others present.

As a safeguard, the Closed Transition Transfer Option provides a reverse power relay for each source. If both sources might be left in the closed position due to some form of a malfunction, the reverse power relays will sense a reverse power flow condition, if present, and trip/cross trip both sources. One or multiple alarms are generated, and individual reverse power, form “C” relay contacts, will changed state to indicate system trouble.

8.14. Battery Charger - BC (Optional)

This option provides a 12Vdc battery and charger kit for the LSE8600 microprocessor controls. It will automatically fix the transfer switch code to “M” for the relay DC voltage. Please refer to the transfer switches schematics for reference.

8.15. Dual Prime Source - DPS (U-to-U) (Optional)

This option allows for selection between two utilities to provide power to the load. A selector switch is provided to indicate which source is preferred when both are available. The LSE8600 detects this input and constantly monitors for the preferred source.

8.16. Utility-to-Generator System (Standard)

This option allows for selection between a utility and a standby generator to provide power to the load. The utility is always the preferred source in this system setup. If, at any time, the utility power is lost, a generator start signal is sent to the standby generator and the load is transferred when it is ready to be loaded.

The LSE8600 monitors both sources constantly and will return the load to utility power after a short time delay. The time delay is to prevent nuisance tripping.

8.17. Generator-to-Generator System (Optional)

This option allows for selection between two generators to provide power to the load. A selector switch is provided to indicate which source is preferred. Both “Engine Start” signals must be connected during ATS Start Up for the LSE8600 to have the ability to call for either generator. There is a fixed cool down PLC timer set (factory set to 15mins) for the generator connected to S1. If a different time delay is required, please indicate this at time of ordering, or a field program update, with a PC, will be required. The timer may be changed for S2 from the front control face for source S2 generator.

The LSE8600 constantly monitors both S1 and S2 for the preferred source.

8.18. Multifunction Digital Meter - DM (Optional)

This option provides Load Monitoring CT’s that are wired directly into the LSE8600 controller. The LSE8600 will leave the factory pre-programmed for the customers system setup. The unit measures the following (S1 /S2):

- | | |
|-----------------------------------|---------------------------------|
| 1. Phase to Neutral Voltage (L-N) | 8. Load (Ph-N kV A) |
| 2. Phase to Phase Voltage (L-L) | 9. Load (Total kV A) |
| 3. Frequency (Hz) | 10. Power Factor |
| 4. Phase Current (Ix) | 11. Power Factor Average |
| 5. Earth Current (Ie) | 12. Load (Ph-N kVAR) |
| 6. Load (Ph-N kW) | 13. Load (Total kVAR) |
| 7. Load (Total kW) | 14. Load (kW h, kV A h, kVAR h) |

If communications are required for the meter, an RS-485 module is provided. If an ethernet based communications setup is needed, a DSE891 module may be used convert the RS-485 modbus to ethernet modbus and may be communicated with via DSENet for remote monitoring and control. Please consult the factory for the appropriate equipment.

8.19. Datalogging (Standard)

The LSE8600 has on board datalogging available for standard transfer switch operation. Below is a list of the recommended variables that may be monitored by the controller.

- Normal Power Available
- Emergency Power Available
- Switch on Normal
- Switch on Emergency
- System in Auto Mode
- S1 Phase Rotation Alarm
- Common Electrical Trip
- Common Alarm
- Common Warning
- S2 Phase Rotation Alarm
- Close S1 Output
- Close S2 Output
- Open S1 Output
- Open S2 Output
- Peak Shave (PS)
- Load Demand Inhibit (LDI)
- Remote Disconnect (RD)
- Fail to Close S1
- Fail to Close S2

NOTE: There are twenty available slots to monitor required variables.

8.20. Phase Sequence Monitor - PSM (Standard)

Phase Sequence Monitoring is automatically included with the LSE8600 controller. If there is a problem with the connections, the LSE8600 display will show the warning. Correct as needed.

8.21. Strip Heater - SH (Optional)

This option provides heaters with an adjustable thermostat inside the enclosure of the transfer switch. The purpose is to help control condensation on the control equipment. When installing the transfer switch, it is important to make sure that all cables coming into the enclosure have the proper sealant installed around them.

8.22. Single Phase Protection - SPP (Standard)

Single Phase Protection is automatically included with the LSE8600 controller. If there is a problem with the source, the controller will perform the appropriate actions to transfer the load to the standby source, and there will be an Alarm displayed on the LSE8600 controller screen.

The LSE8600 controller has a dedicated output to indicate any type of alarm status that can be used to contact the appropriate personnel to review the problem and correct the system.

9. Appendixes

9.1. Appendix A

Tension Adjustment for Transfer Mechanism of Lake Shore Electric Transfer Switch

Refer to Figure 39 - Gear Motor Assembly (page 51).

When excess slippage occurs in the friction drive, it is necessary to increase the tension on the friction drive shoe lining. Turn the adjustment screw (3) clockwise to increase the tension. This action compresses the tension spring (9), and thus increases the friction. The adjustment screw should not be tightened all the way.

Proper adjustment of the tension on the drive shoe may be set by the following method. With the Automatic Transfer Switch in the Normal position, use a marker to make a line on the drive drum (8) along the edge of the drive shoe (12). Transfer the switch automatically either by the Load Test switch or interrupting the Normal source power.

After the switch has transferred to the Emergency position, observe the position of the line on the drive drum. The line position should be approximately 1/2" to 3/4" from the edge of the drive shoe indicating slippage. Transfer switches utilizing smaller circuit breakers are equipped with a single friction drive arm, as they require less force to activate. On these switches an idle arm with no adjusting screw replaces one of the drive arms. If both drive drums are used for transferring the switch, the spring tension on the drive shoes should be adjusted equally. Please note that this is an approximate setting, and it may be necessary to try the transfer switch several times to assure that the adjustment is sufficient.

Do not tighten the adjustment screw to its limit as this will compress the spring entirely and cause the operating mechanism to jam. When this happens, the gears may strip or the roll pins inside the gearbox may shear. Sheared roll pins and/or stripped gears are indicated when the motor operates but does not turn the drive drum. This situation can only be remedied by replacing the motor gearbox.

Over time, the spring may lose its tension. This is indicated when the motor operates and the drive drum turns, but the unit does not have sufficient friction to operate the circuit breakers. In this case, the spring must be replaced with a new one.

9.2. Appendix B

***FIELD CABLE SIZE & LUG TORQUE REQUIREMENTS**
USE COPPER WIRE ONLY
LINE-LOAD-NEUTRAL UNLESS OTHERWISE SPECIFIED

REQUIRED MAINTENANCE

The following cable lug torques are required to be checked every six months to maintain the Lake Shore Electric Corporation exclusive "one year" warranty.

I. TORQUE - SOCKET HEAD SCREWS

Socket Size (inches)	
Across Flats	Torque (LB-IN.)
1/8	45
5/32	100
3/16	120
7/32	150
1/4	200
5/16	275
3/8	375
1/2	500
9/16	600

Warning: Whenever bus and cable connections are being maintained, all power sources to the transfer switch must be disconnected and locked out.

9.3. Appendix C

INTERNAL MOLDED CASE TORQUE REQUIREMENTS

REQUIRED MAINTENANCE

The following lug torques are required to be checked every six months to maintain the Lake Shore Electric Corporation exclusive "one year" warranty.

I. EATON (CUTLER-HAMMER) LUG TO MOLDED CASE SWITCH

K - Frame	6 - 8 LBS. - FT.
L - Frame	6 - 8 LBS. - FT.
N - Frame	31.25 - 37.5 LBS. - FT.

II. EATON (CUTLER-HAMMER) TRIP TO MOLDED CASE SWITCH

K - Frame	6 - 8 LBS. - FT.
L - Frame	10 - 12 LBS. - FT.
N - Frame	N/A Electronic Trip Unit

9.4. Appendix D

FOR FUTURE USE

9.5. Appendix E

FOR FUTURE USE